

ArrowMaster 55

KIT # K-505

Assembly Instructions



Version 2 06-13-14

WARRANTY

Alien Aircraft Corp. guarantees this kit to be free from defects in both material and workmanship at the date of purchase. This warranty does not cover any component parts damaged by use or modification. In no case shall Alien Aircraft Corp.'s liability exceed the original cost of the purchased kit. Further, Alien Aircraft Corp. reserves the right to change or modify this warranty without notice. The quality and flyability of your finished model depends on how you build it; therefore, we cannot in any way guarantee the performance of your completed model, and no representations are expressed or implied as to the performance or safety of your completed model.

In that Alien Aircraft Corp. has no control over the final assembly or material used for final assembly, no liability shall be assumed nor accepted for any damage resulting from the use by the user of the final user-assembled product. By the act of using the user-assembled product, the user accepts all resulting liability. If the buyer is not prepared to accept the liability associated with the use of this product, the buyer is advised to return this kit immediately in new and unused condition to the place of purchase.

WARNING!!!

Failure to follow these safety precautions may result in severe injury to yourself and others.

Use safety glasses when running the motor. Do not run the motor in an area of loose gravel or sand; the propeller may throw such material in your face or eyes. Keep your face and body as well as all spectators away from the plane of rotation of the propeller as you run the motor. Keep these items away from the prop: loose clothing, shirt sleeves, ties, scarfs, long hair or loose objects such as pencils or screwdrivers that may fall out of shirt or jacket pockets into the prop. Always remove the LiPo battery from the plane before charging. Always use a charger designed to charge LiPo batteries for charging the LiPo flight battery. Never leave the LiPo battery unattended while charging. If the battery becomes more than just warm, discontinue charging.



Alien Aircraft Corp.

403-A Flomich Street
Holly Hill, FL. 32117
(386)676-0074

© 2014 Alien Aircraft Corp

Notes about the laser cut parts

- 1...*The first thing that you need to do is to identify and mark the part numbers on the laser cut parts using the drawings on the following pages as a guide.*
- 2...It is possible that several of the laser cut parts may not be completely cut through. If this is the case you can free the part from the sheet quickly using an X-acto knife.
- 3...The slight discoloration on the edges of the laser cut parts may be removed by lightly sanding the edges with 400 grit sandpaper.

Kit Contents:

Your kit contains the following parts. Please check your kit for any missing or damaged parts before starting construction.

Wood Bag:

Qty.	Name	Description
1	LC-505-01	.3mm X 4" X 24" Laser Cut POPLAR PLY
1	LC-505-02	.3mm X 8" X 24" Laser Cut POPLAR PLY
1	LC-505-03	.3mm X 4" X 24" Laser Cut POPLAR PLY
1	LC-505-04	.3mm X 8" X 24" Laser Cut POPLAR PLY
1	LC-505-05	.3mm X 4" X 24" Laser Cut POPLAR PLY
1	LC-505-06	.3mm X 4" X 24" Laser Cut POPLAR PLY
1	LC-505-07	.3mm X 8" X 24" Laser Cut POPLAR PLY
1	LC-505-08	.3mm X 8" X 24" Laser Cut POPLAR PLY
1	LC-505-09	.3mm X 4" X 24" Laser Cut POPLAR PLY
1	LC-505-10	1/8" X 4" X 24" Laser Cut BALSA
1	LC-505-11	1/8" X 4" X 24" Laser Cut BALSA
1	LC-505-12	1/8" X 4" X 24" Laser Cut BALSA
1	LC-505-13	1/8" X 4" X 24" Laser Cut BALSA
1	LC-505-14	1/8" X 4" X 24" Laser Cut BALSA
1	LC-505-15	1/8" X 4" X 24" Laser Cut BALSA
1	LC-505-16	1/8" X 4" X 24" Laser Cut BALSA
1	LC-505-17	1/8" X 4" X 24" Laser Cut BALSA
1	LC-505-18	1/8" X 4" X 24" Laser Cut BALSA
1	LC-505-19	1/8" X 4" X 24" Laser Cut BALSA
1	LC-505-20	1/8" X 4" X 24" Laser Cut BALSA
1	LC-505-21	1/8" X 4" X 24" Laser Cut BALSA
1	LC-505-22	3/32" X 4" X 24" Laser Cut BALSA
1	LC-505-23	3/32" X 4" X 24" Laser Cut BALSA
1	LC-505-24	3/32" X 4" X 24" Laser Cut BALSA
1	LC-505-25	3/32" X 4" X 24" Laser Cut BALSA
1	LC-505-26	3/32" X 4" X 24" Laser Cut BALSA
1	LC-505-27	3/32" X 4" X 24" Laser Cut BALSA
1	LC-505-28	3/32" X 4" X 24" Laser Cut BALSA
1	LC-505-29	3/32" X 4" X 24" Laser Cut BALSA
4	LC-505-30	3/32" X 4" X 24" Laser Cut BALSA
1	LC-505-31	1/16" X 4" X 24" Laser Cut Birch Ply
1	LC-505-32	1/32" X 4" X 12" Laser Cut Birch Ply
9	Tail Sheet	1/16" x 4" x 24" Balsa
3	Wing Sheet	3/32" X 4" X 24" Balsa
1	Windshield	.015" x 3" x 7" Plastic

Plans Bag:

Qty	Name	Description
1	K-505 PLAN A	
1	K-505 PLAN B	
1	K-505 PLAN C	
8	Main Wing Spars	.1/8" x 3/8" x 36" Bass
9	Wing Leading Edge & Jig, Fuselage Stringers, Braces & Fillers.....	1/4" x 1/4" x 36" Balsa
8	Wing Trailing Edge	.3/32" x 1" x 36" Balsa
5	Fuselage Stringers	.1/8" x 1/4" x 36" Balsa
1	Upper Jig & Cowl	.3/8" x 3/8" x 36" Balsa
2	N Struts	.3/16" x 3/8" x 36" Bass
1	Fuselage Braces	.1/4" Triangle x 12" Balsa

Misc. Loose Parts

Qty	Name	Description
8	Wing Leading Edge Sheet	.3/32" x 3" x 36" Balsa
1	Cowl Sheet	.1/4" x 2" x 36" Balsa
1	Cowl Sheet	.1/4" x 2" x 6" Balsa
2	Main Landing Gear L & R	Formed Aluminum
2	Cabane Struts L & R	Formed Aluminum
1	Tail Wheel Wire	.1/16" x 6" Music Wire

Hardware Bag

Qty	Name	Description
1	Tailwheel Bracket	Molded Nylon Bracket
8	"N" Strut Fittings	Molded Nylon Straps
8	Top Wing & Motor Mount Blind Nuts	.6-32 Blind Nuts
4	Cabane	.6-32 x 1/2" Screws
1	Elevator Joiner Dowel	.1/4" x 4 1/2" Birch Dowel
2	Wing Dowels	.1/4" x 1" Birch Dowel
2	Wing Bolts	.1/4-20 x 1" Nylon Screw
4	Control Horn	Aileron and Tail Large Control Horns
22	#2 Sheet Metal Screws	# 2 X 1/2" Sheet Metal Screw
4	Tail Horn Screws	.2-56 x 1/2" Machine Screw
4	Aileron Servo Mounts	.3/8" x 3/8" x 1" Bass
20"	Bottom Wing Joint Tape	.2" x 20" Dacron Tape
48"	Top Wing Joint Tape, Elevator & Tailwheel	.1" x 48" Dacron Tape
2	Aileron Horn Wedge Blocks	.3/16" x 1/2" x 1/2" Bass
8	"N" Strut Blocks	.3/8" x 3/8" x 3/8" Bass
8	"N" Strut	.4-40 x 3/8" Machine Screws
8	"N" Strut	.4-40 Blind Nuts
8	Axle Nuts	.8-32 Nuts
2	Axles	.8-32 x 2" Bolt
2	Axle Washers	.8-32 Washers

Additional Items Required (Not Included in Kit)

Qty	Name	Description
1	Covering Material	3 Rolls Covering Material Plus Trim Colors
17	Tail & Aileron Hinges	C/A or Pin Style Hinges
2	Tail Pushrods	DuBro 30" Laser Rods (1 pair) (Alien Aircraft P/N: AH-013)
2	Aileron Pushrods	12" 2-56 Pushrods (1 pair) (Alien Aircraft P/N: AH-014)
1	Tail L/G Collar	1/16" Wheel Collar (DuBro P/N: 137)
2	Main Wheels	3-1/2" Wheels (DuBro P/N: 350TL)
1	Tail Wheel	1" Tail Wheel (Sullivan P/N: 100TW)
1	Radio	4 Channel Radio with Receiver
2	Tail Servos	HiTec HS-311 Standard Servos or Equivalent
2	Aileron Servos	HiTec HS-311 Standard Servo or Equivalent
1	Throttle Servo	HiTec HS-311 Standard Servo or Equivalent
1	Throttle cable to servo	DuBro EZ Connector (DuBro #121)
1	Aileron "Y" Connector	.6" "Y" Connector to fit your radio
1	Aileron Servo Extension	.6" Servo Extensions to fit your radio
1	Motor	2-stroke .65-.90 or 4-stroke .70-.95 or 15cc Gas
1	Motor Mount	Dave Brown Motor Mount (to fit your motor)
4	Motor Mount to Firewall	.6-32 Machine Screws (length to fit your motor)
4	Motor to Mount	.6-32 Machine Screws (length to fit your motor)
1	Propeller	13" x 5" Propeller (or size to fit your motor)
1	Fuel Tank	DuBro Square Fuel Tank 12 oz (Dubro # 412)
1	Throttle Pushrod	DuBro Throttle Cable Assembly (Dubro # 3105)
1	Fuel Line	Medium Fuel Line (DuBro #222)
1	Foam Rubber	1/4" Foam Rubber (DuBro # 513)
1	Spinner	DuBro 3" Spinner

Optional Items:

1 Pair	Wheel Pants	Fiberglass Specialties #23 Wheel Pants
4	Wheel Pant Nuts	4-40 Blind Nuts
4	Wheel Pant Screws	4-40 x 3/8" Machine Screws
2	Axle Nuts	.8-32 Nuts (in addition to the eight in the kit)

Note: We decided not to put wheel pants in the kit because many builders would not use them. And if we put them in the kit they would be vac-formed plastic, which is flimsy and a pain to assemble. However, we found a great set of epoxy glass wheel pants from Fiberglass Specialties that look great, are rugged, and fit perfectly.

Their contact info is:

Fiberglass Specialties

15715 Ashmore Dr.

Garfield, Arkansas 72732

Phone 479 359-2429

Web Site: <http://www.fiberglassspecialtiesinc.com/>

If you buy the Fiberglass Specialties #23 wheel pants, email us a copy of the receipt and we will send you a **FREE SET OF MOUNTING HARDWARE** as listed above.

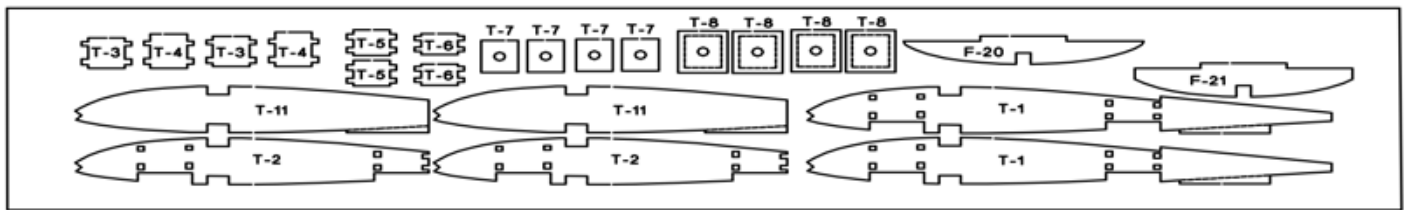

LC-505-01 3mm X 4" X 24" Poplar Ply 1 REQD.

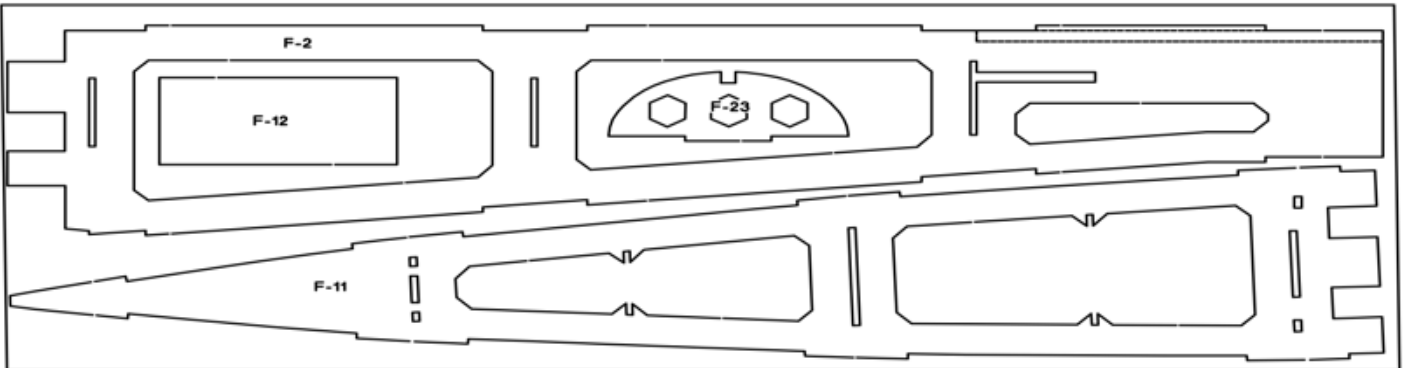

LC-505-02 3mm X 8" X 24" Poplar Ply 1 REQD.

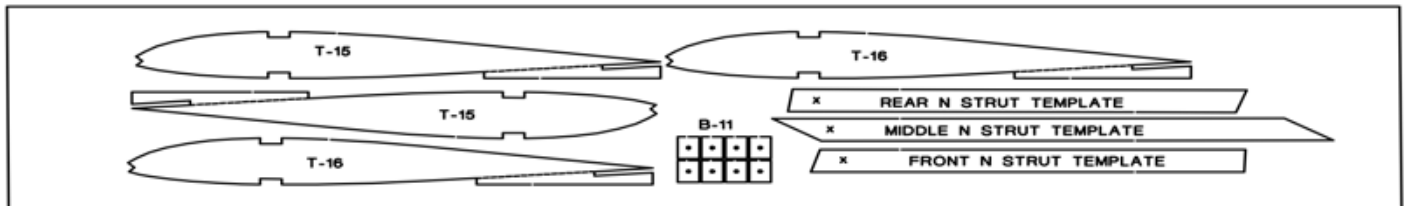

LC-505-03 3mm X 4" X 24" Poplar Ply 1 REQD.

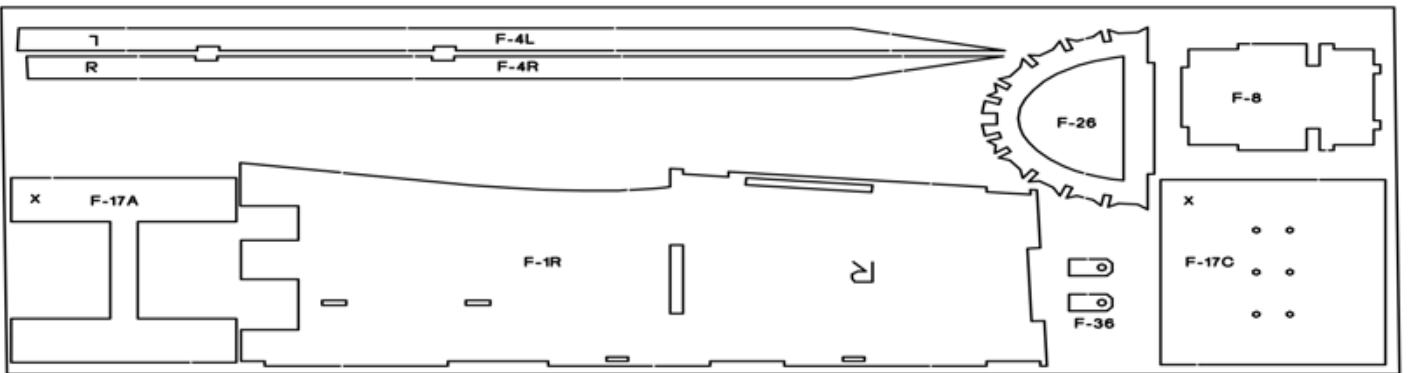

LC-505-04 3mm X 8" X 24" Poplar Ply 1 REQD.

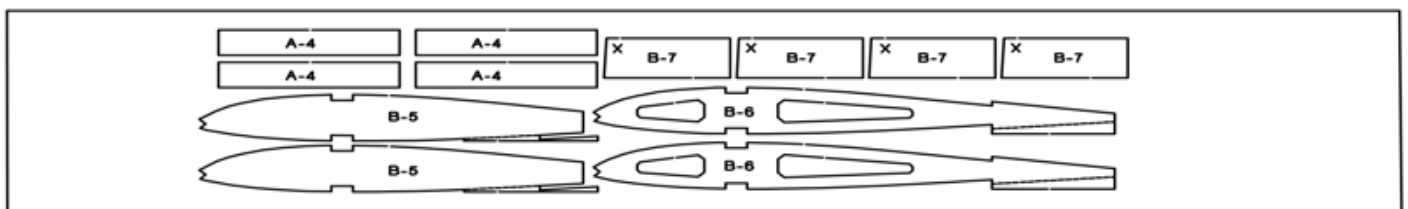

LC-505-05 3mm X 4" X 24" Poplar Ply 1 REQD.

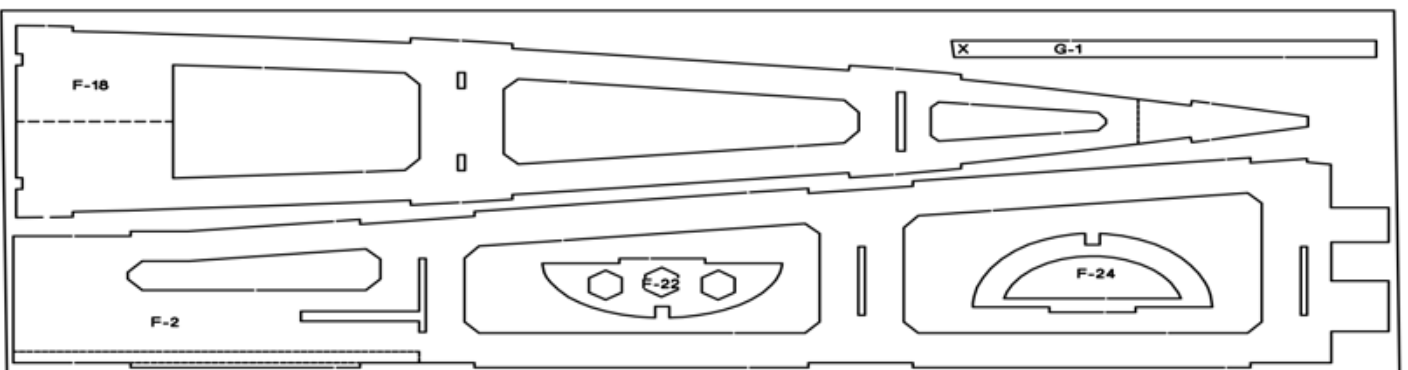

LC-505-06 3mm X 8" X 24" Poplar Ply 1 REQD.

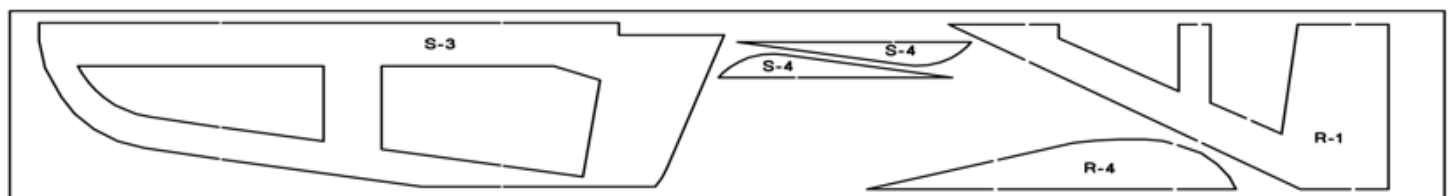
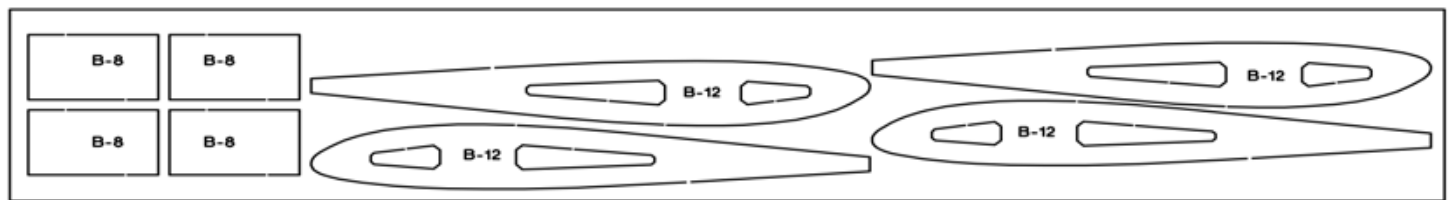
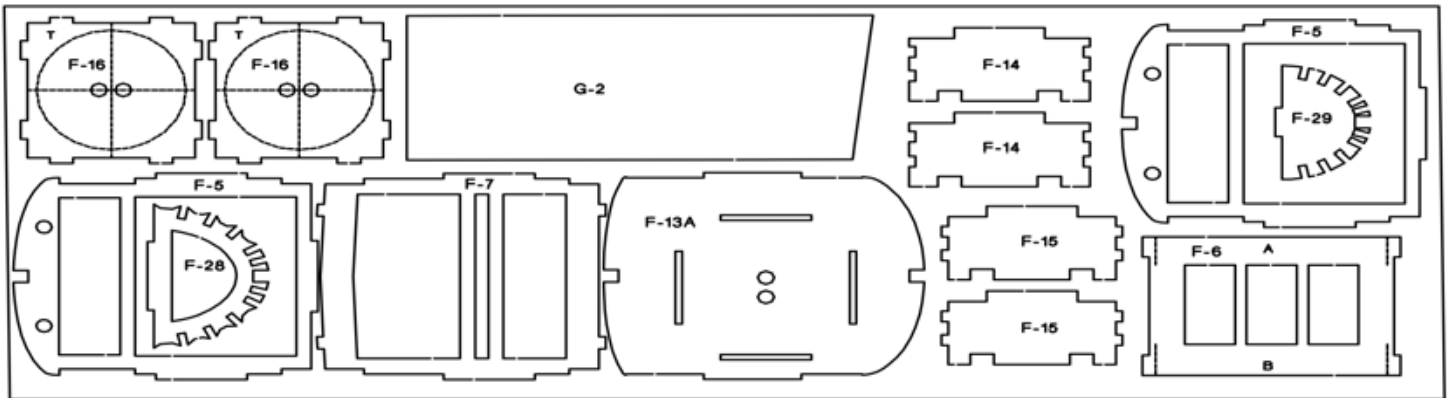
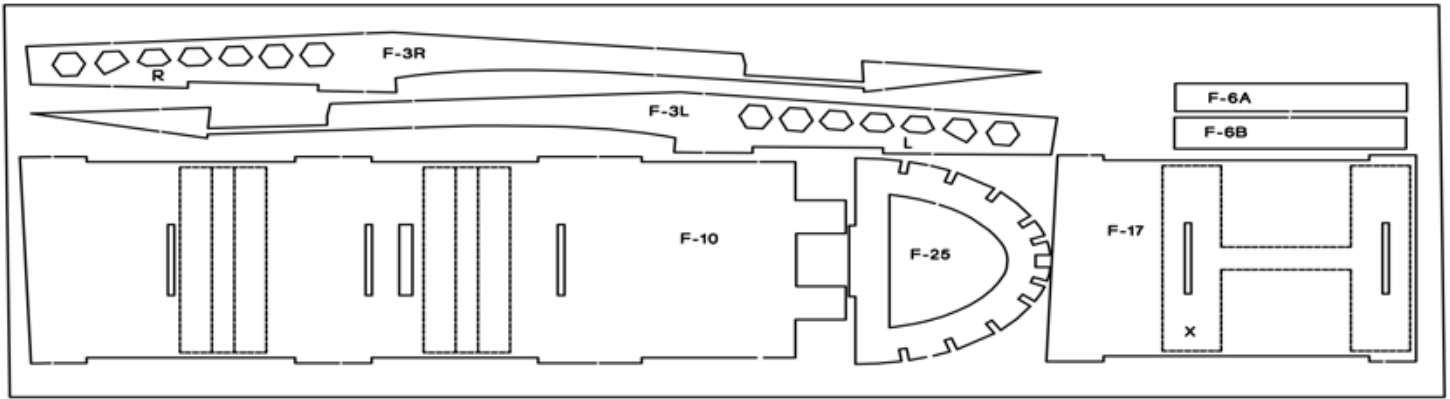
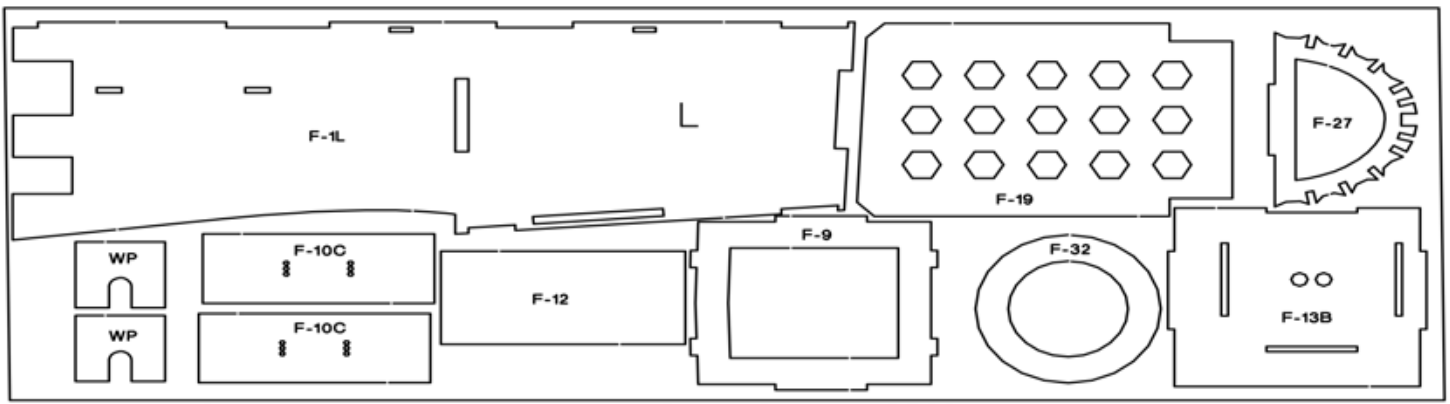

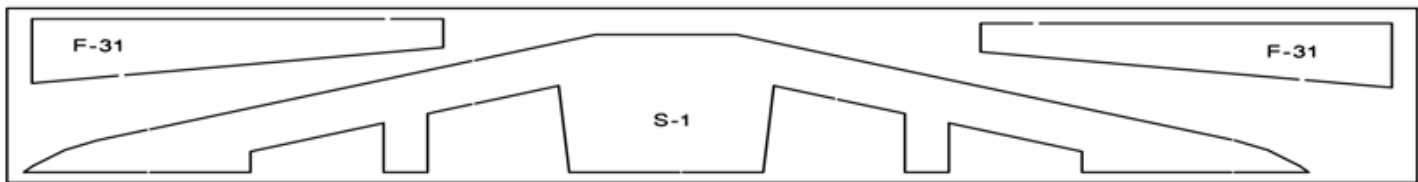

LC-505-13 1/8" X 4" X 24" BALSA 1 REQD.

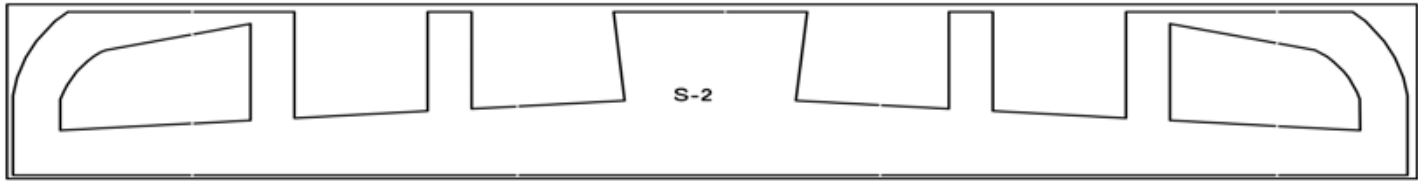

LC-505-14 1/8" X 4" X 24" BALSA 1 REQD.



LC-505-15 1/8" X 4" X 24" BALSA 1 REQD.

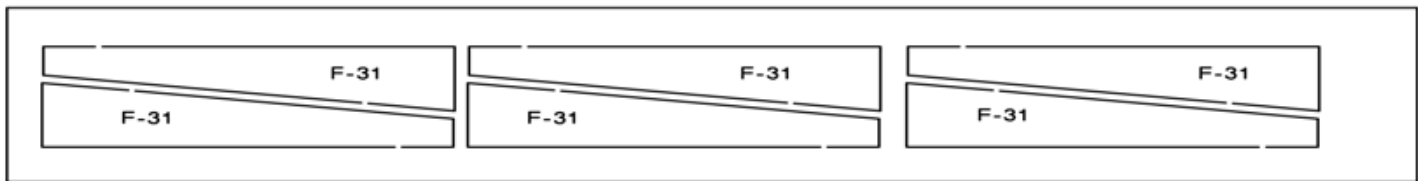

LC-505-16 1/8" X 4" X 24" BALSA 1 REQD.



LC-505-17 1/8" X 4" X 24" BALSA 1 REQD.

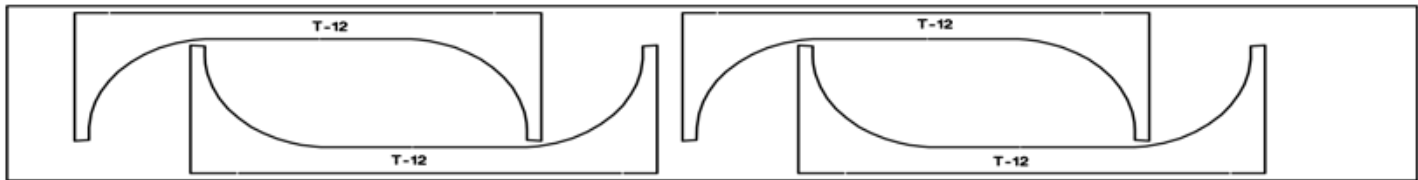

LC-505-18 1/8" X 4" X 24" BALSA 1 REQD.

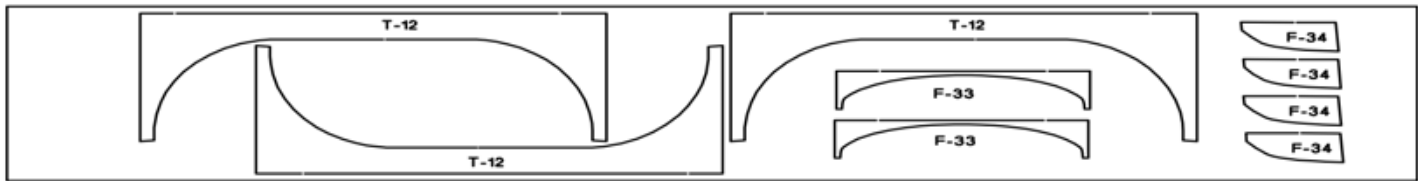

LC-505-19 1/8" X 4" X 24" BALSA 1 REQD.

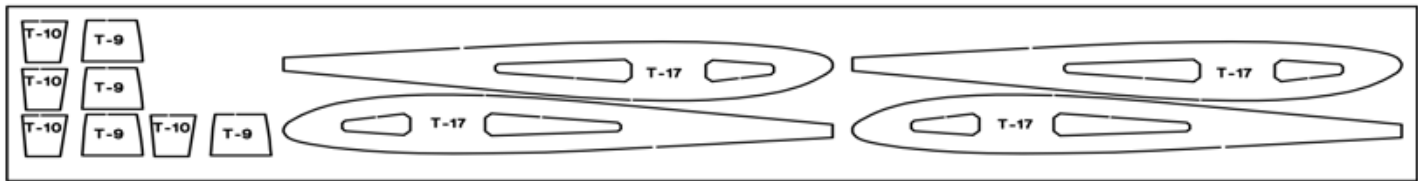

LC-505-20 1/8" X 4" X 24" BALSA 1 REQD.

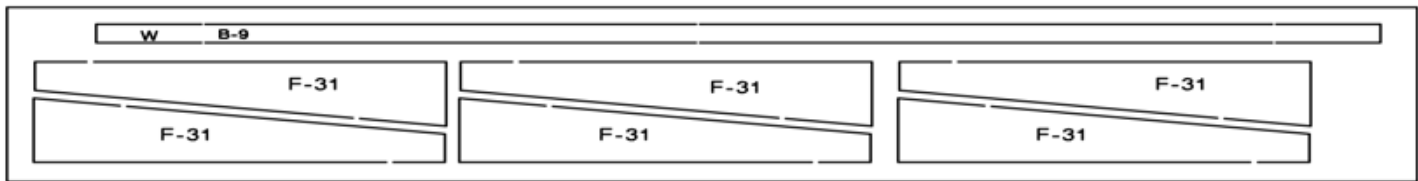

LC-505-21 1/8" X 4" X 24" BALSA 1 REQD.

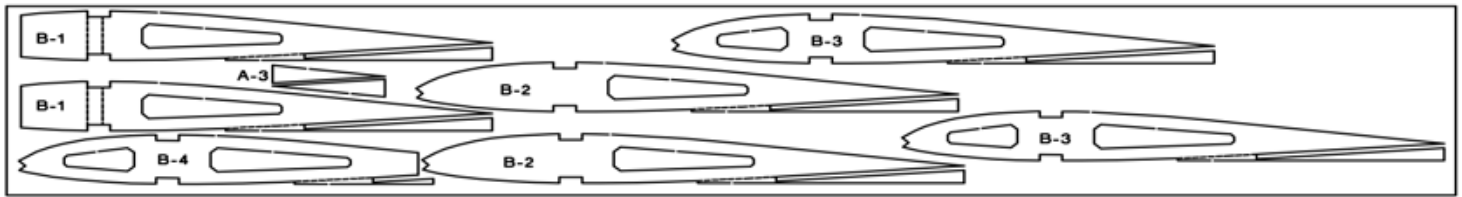

LC-505-22 3/32" X 4" X 24" BALSA 1 REQD.



LC-505-23 3/32" X 4" X 24" BALSA 1 REQD.

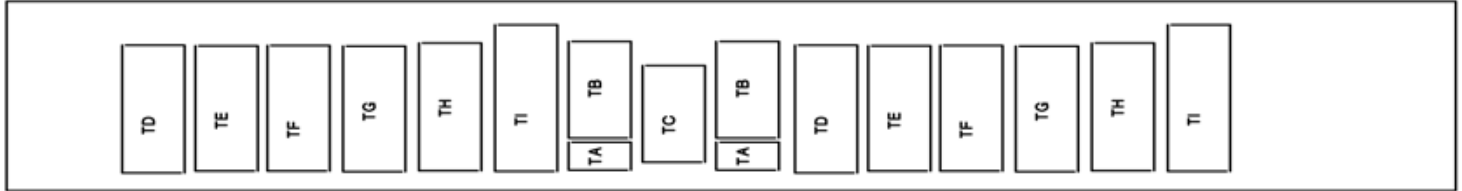

LC-505-24 3/32" X 4" X 24" BALSA 1 REQD.

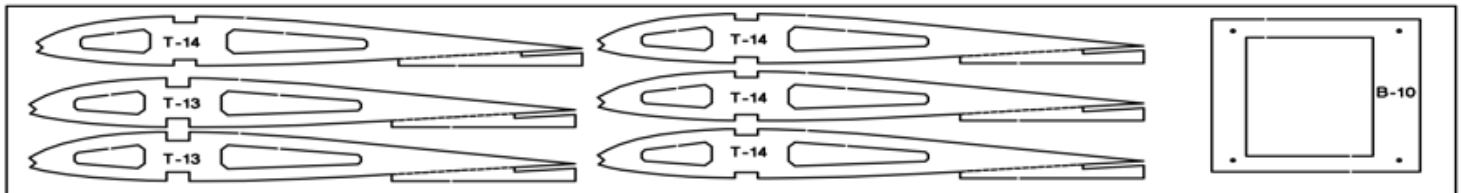

LC-505-25 3/32" X 4" X 24" BALSA 1 REQD.



LC-505-26 3/32" X 4" X 24" BALSA 1 REQD.

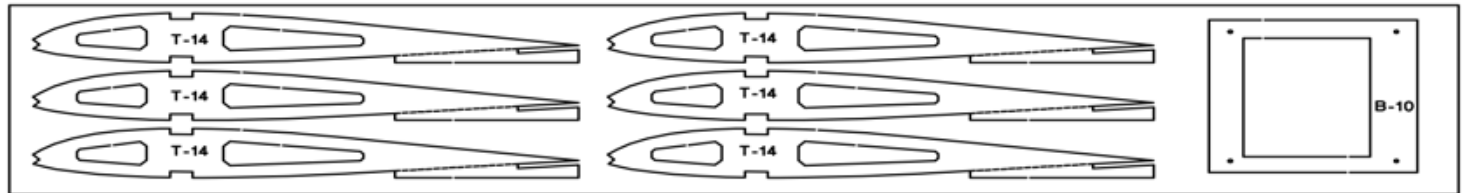

LC-505-27 3/32" X 4" X 24" BALSA 1 REQD.

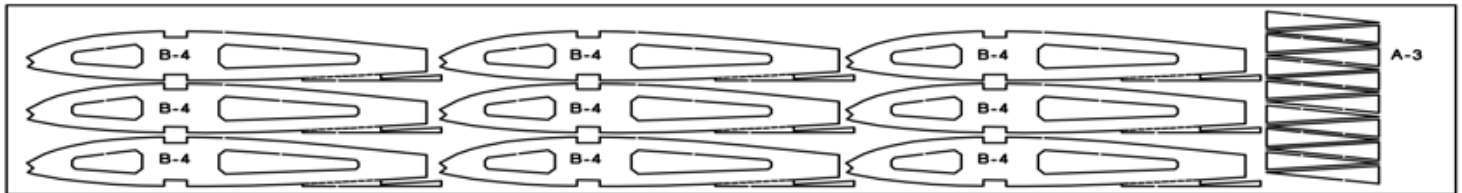

LC-505-28 3/32" X 4" X 24" BALSA 1 REQD.

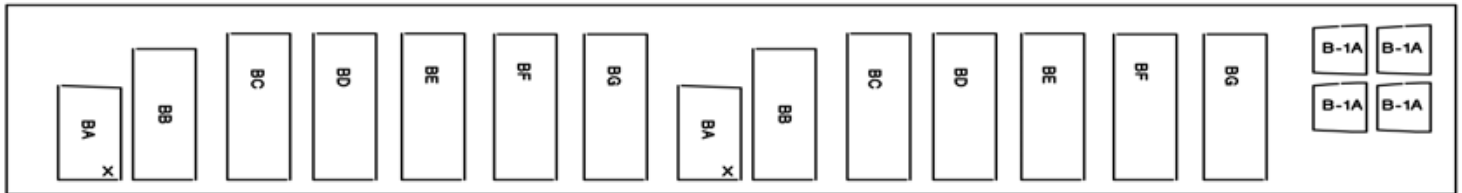

LC-505-29 3/32" X 4" X 24" BALSA 1 REQD.

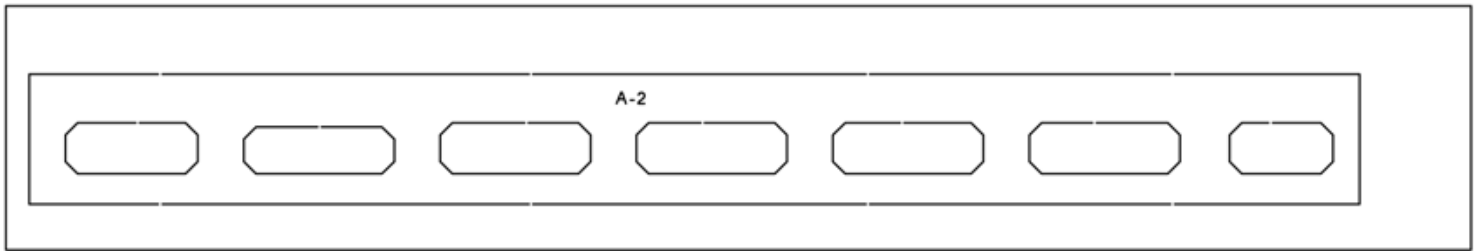

LC-505-30 3/32" X 4" X 24" Balsa 4 REQD.

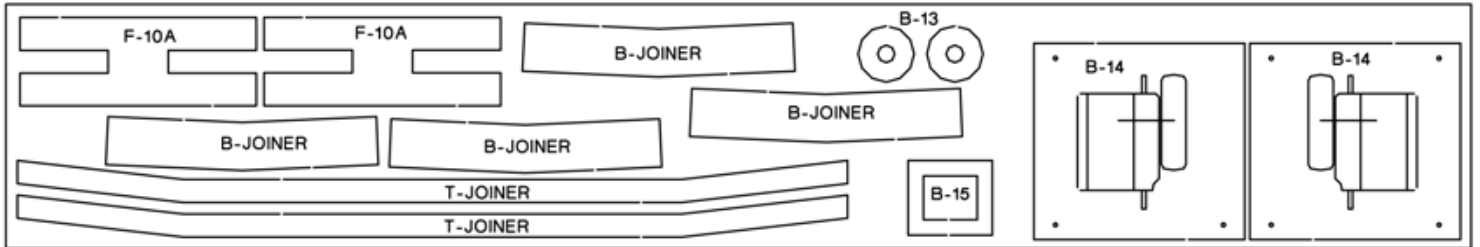

LC-505-31 1/16" X 4" X 24" BIRCH PLY 1 REQD.

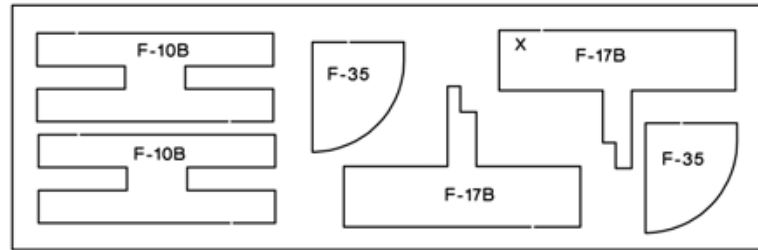

LC-505-32 1/32" X 4" X 12" BIRCH PLY 1 REQD.

Building Instructions: General Note: Cover the plans with wax paper before assembling your model to prevent the parts from sticking to the plan.

Note: The shape of some of the lightning holes in the tail surfaces and rear fuselage have been changed and may not match the photos in the instructions. However, this has no impact on the assembly which remains the same.

Building the Tail Surfaces:

1... Glue S-1 and S-2 together as shown to make the stabilizer. Glue two sets of S-3 and S-4 together as shown to make the elevators.



2...Edge glue together two pieces of 1/16" x 4" x 24" balsa sheet as shown to make the skins for the tail surfaces. Make two more sets for a total of 3 skins.



3...Glue this sheet to one side of the stabilizer. A thin coat of Titebond style glue works well. Hold flat to prevent any warps or twists while the glue dries.

Do not use excess glue. Keep the tail light.



4...Trim the sheet flush with S-1 / S-2. Save the cut off scrap pieces.



5...Now sheet and trim the opposite side as you did the first. Hold flat to prevent any warps or twists while the glue dries. Save the cut off scrap pieces.



6...Glue R-1 and R-2 together to make the fin. Sheet one side of the fin. Hold flat to prevent any warps or twists while the glue dries. Trim the sheet and then sheet the other side and trim. Hold flat to prevent any warps or twists while the glue dries.



7...Glue R-3 and R-4 together to make the rudder. Glue the S-3's and S-4's together to make the elevators. Use 1/16" balsa to sheet both sides of the elevators. Use 1/16" balsa to sheet both sides of the rudder.



8...Join the elevators using the 1/4" x 4-1/2" dowel. Use the stabilizer as a guide to establish the proper spacing. Trim the dowel to achieve the proper length if required.



9...Bevel the front edge of the rudder as shown on the plan, and sand the other edges of the fin and rudder round. Leave the bottom edges of the fin that will contact the fuselage square.

Mark the hinge locations and cut the hinge slots. Temporarily install the hinges without glue.



10...Bevel the front edge of the elevators as shown on the plan, and sand the other edges round. Sand the front and ends of the stabilizer round. Leave the back edge square.

Mark the hinge locations and cut the hinge slots. Temporarily install the hinges without glue.



11...Cut two 2" pieces of the 1" nylon tape. Glue this tape around the dowels on each elevator.



Building the Bottom Wing:

Cover the right wing plan with wax paper to prevent the parts from sticking to the plan.

12...Cut the following pieces: four $\frac{3}{32}$ " x 3" x 36" balsa sheets, two $\frac{1}{4}$ " sq. x 36" balsa sticks, four $\frac{1}{8}$ " x $\frac{3}{8}$ " x 36" Bass sticks, and four $\frac{3}{32}$ " x 1" x 36" balsa strips to a length of 30". Save the cutoff pieces.

13...Glue two B-12's together to make one wing tip. Repeat to make a second wing tip.



14...Glue the four bottom wing joiners (B-Joiner) together.



15...Glue two B-8's together. Repeat to make a second assembly.



16...Glue two B-7's together. Repeat to make a second assembly. Note: one edge of the B-7's has a slight angle. Be sure that this angle is lined up on the two pieces when you glue them together.



17...Glue two B-9's together. Repeat to make a second assembly.



18...Glue the B-1A's to the B-1 and B-2 ribs. Be sure to make a left and right hand assembly as shown.



Building the Right Bottom Wing:

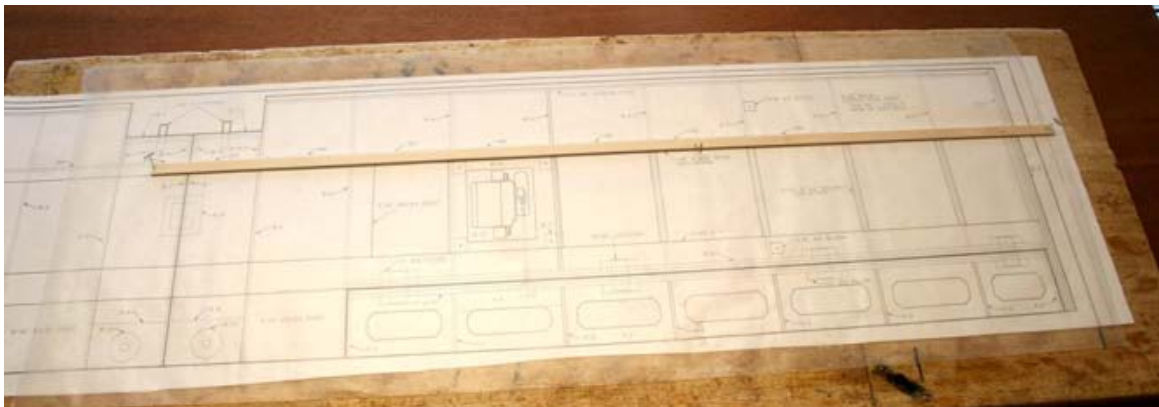

19...Pin one of the 1/8" x 3/8" x 30" bass main spars to the plan. The inboard end should extend a little past the centerline of the wing. The other end will extend past the last rib at the wing tip. This excess will be trimmed off later.

20...Pin and glue rib B-2 into position on the bottom spar. It should be 90 degrees to the building board. The B-1A should face toward the inboard end of the wing.

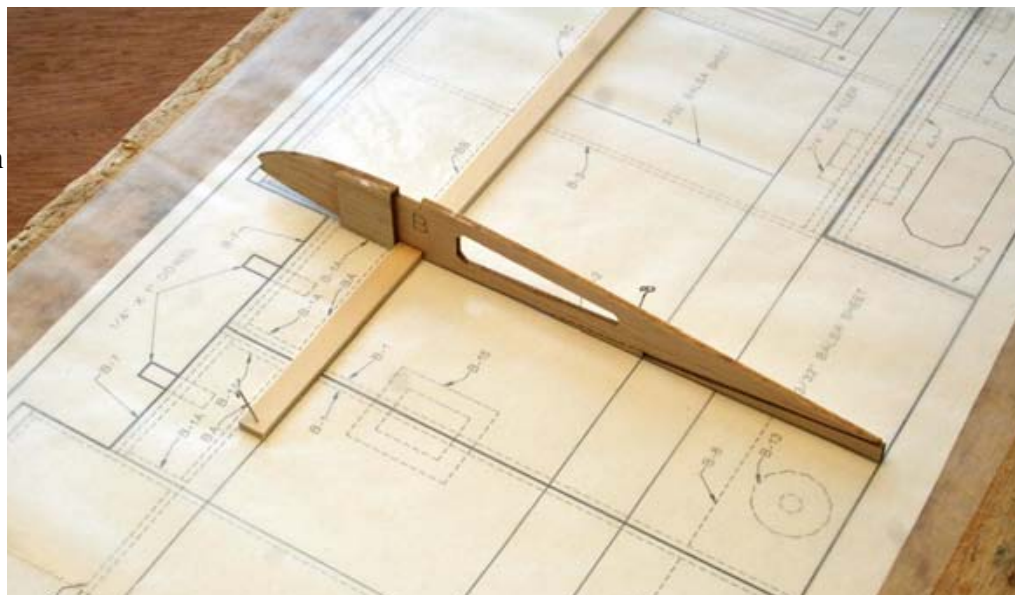

21...Glue shear web "B-A" into position against the front face of the lower spar and against rib W-2 as shown on the plan.

The small "X" on the shear web marks the top outboard corners of the shear web.

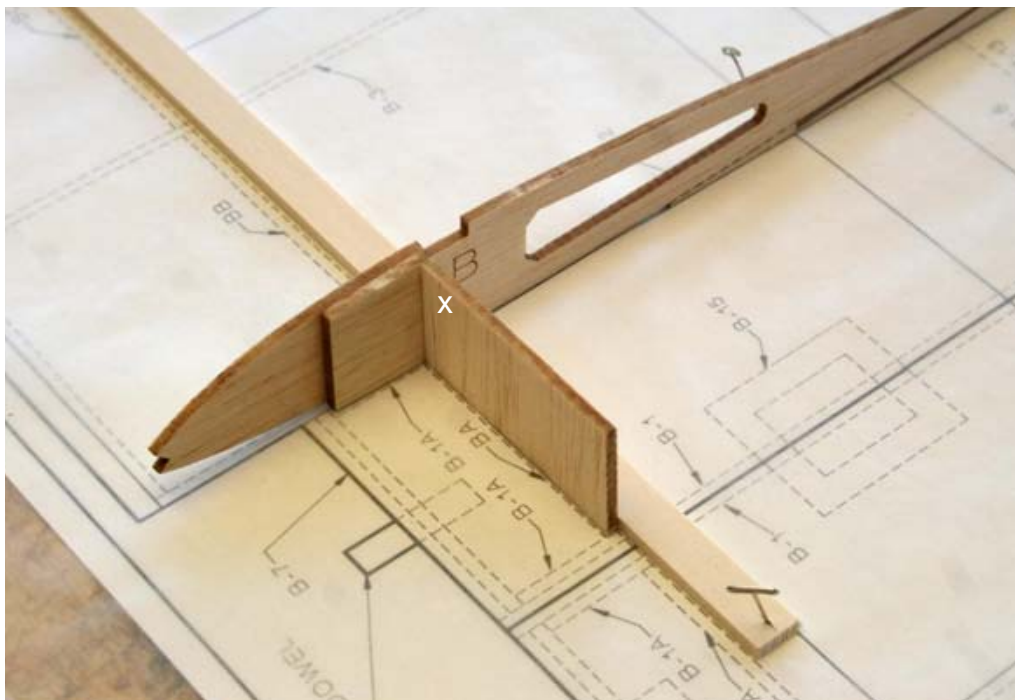

22...Pin and glue rib B-1 into position. The top of the rib should angle slightly toward the wing tip and be in full contact with the shear web.

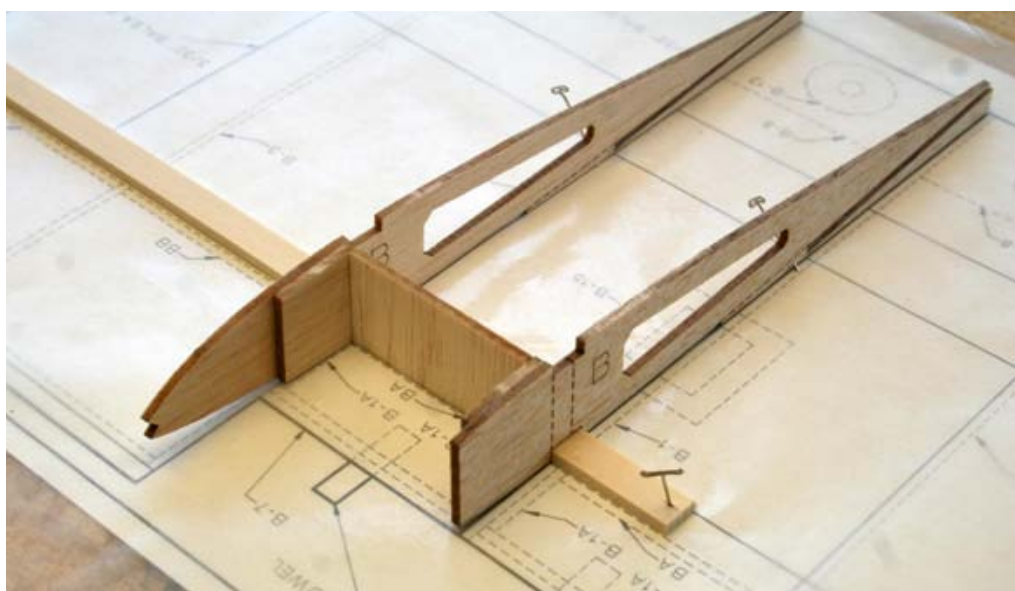

23...Glue the B-7 assembly to the front of the B-1A's on the front of ribs B-1 and B-2. The angled edge is against the W-1 rib. It should be flush at the top and bottom of the ribs.

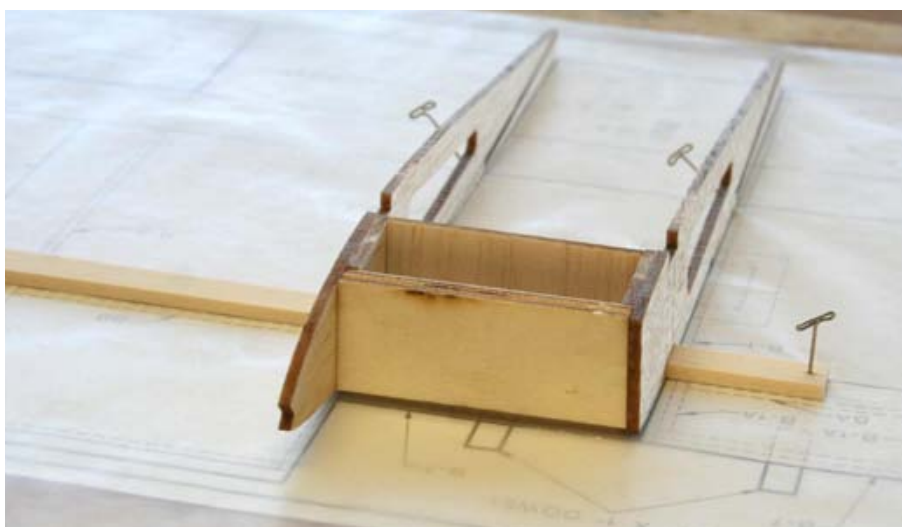

24...Pin and glue ribs B-3, B-4's, B-5 and B-6 into position on the spar. They should be 90 degrees to the building board.

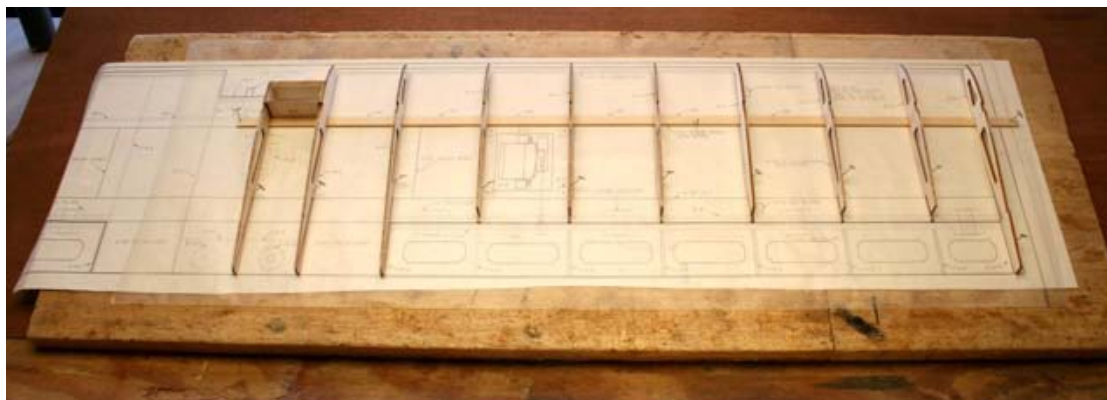

25...Glue the top main spar into position on the ribs.



26...Place the lower 3/32" x 1" x 30" trailing edge sheet into position in the slots in the wing ribs. It should be fully seated in the slots and centered left and right. When properly positioned, glue the trailing edge to the ribs. The ends will be a little long and will be trimmed flush with the end ribs later.

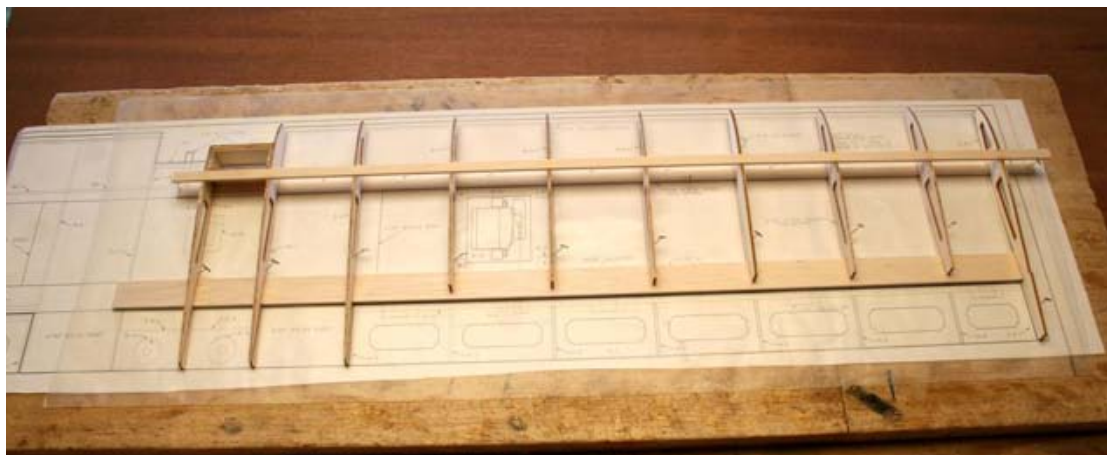

27...Glue the 1/4" sq. x 30" balsa leading edge into position. The inboard end should be flush with the face of rib B-2 and other end should extend past rib B-6.



28...Position and glue one B-9 assembly into place between ribs B-3 and B-6 at the back of the wing. It should be tight against the back of ribs W-4 and W-5. Trim the ends if needed for a tight fit.



29...Glue the remaining shear webs B-B, B-C, B-D, B-E, B-F, and B-G into position. Trim the ends to get the proper fit if needed.



30...Insert a piece of 3/32" x 3" x 6" balsa left over from step 12 into the slots in wing ribs B-1 through B-3 as shown. The outboard end should be flush with rib B-3. The inboard will be long and extend past the B-1 rib. Glue the sheet to the ribs and when the glue is dry, trim the back edge off flush with the end of the ribs.



31...Glue the upper $3/32''$ x $1''$ x $30''$ trailing edge to the top of the wing. The back edge should be flush with the rear face of the B-9 assembly.



32...Trim and sand a taper on B-8 as shown on the plan.



33...Glue B-8 between ribs B-1 and B-2 at the trailing edge of the wing.

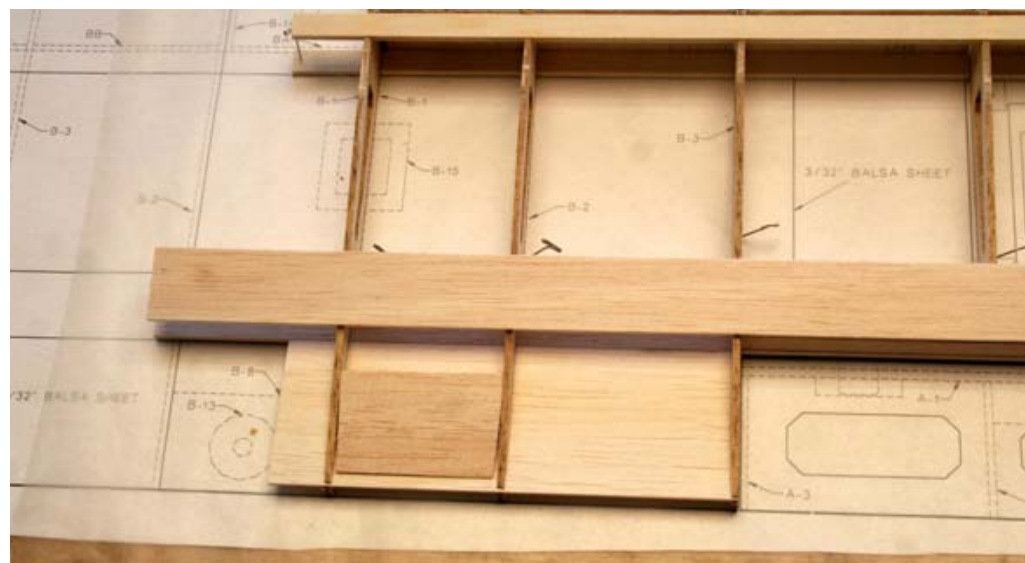

34...Glue a piece of $3/32''$ x $3''$ x $6''$ balsa left over from step 12 onto wing ribs B-1 through B-3 as shown. The outboard end should be flush with rib B-3. The inboard will be long and extend past the B-1 rib. Glue the sheet to the ribs and when the glue is dry, trim the back edge off flush with the lower piece of sheet.



35...Trim 1/4" from one edge of 3/32" x 3" x 30" balsa sheets to make it 2-3/4" wide as shown. Save the 1/4" piece to make the cap strips later.



36...Position the 3/32" x 2-3/4" x 30" leading edge sheet against the leading edge as shown. Center it left and right so it extends slightly past the B-1 rib at the inboard end and slightly past the B-6 rib at the outboard end. When positioned properly, glue the sheet to the 1/4" sq. leading edge only at the angle shown.

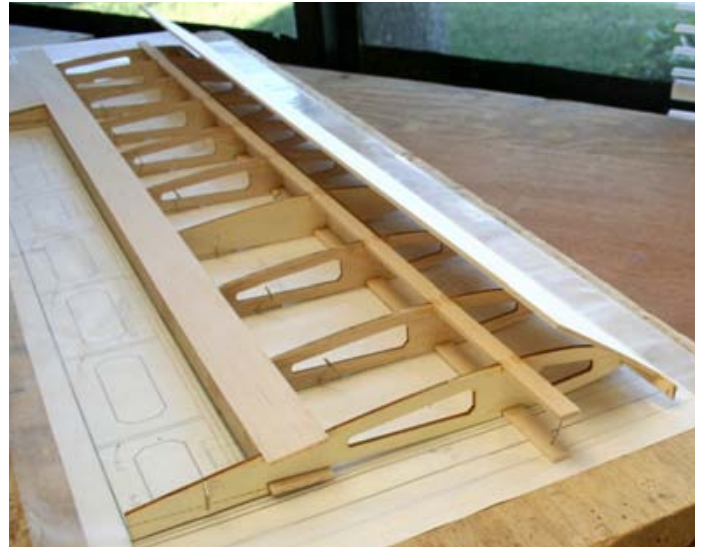

37...Moisten the outside of the leading edge sheet with an ammonia based glass cleaner such as Windex. Allow it to soak in for several minutes. Roll the sheet back and glue thoroughly to the ribs and main spar.



38...Cut two pieces 6" long from one of the 3/32" x 4" x 24" balsa sheets. Use one piece to sheet the inboard end of the wing between ribs B-1 to slightly past B-3. Trim the width to fit between the leading edge sheet and the trailing edge sheet. Glue into position.



39...Cut $\frac{3}{32}$ " x $\frac{1}{4}$ " wide strips from the leading edge cutoff as cap strips and glue into position on top of the B-4, B-5 and B-6 ribs. The cap strips should be centered on the ribs except for B-6. The B-6 cap strip should be flush with the outboard face of the rib and extend inboard. Additional pieces can be cut from one of the $\frac{3}{32}$ " x 4" x 24" sheets if needed.



40...Remove the wing from the plan. Remove the support tabs from the back of the ribs.



41...Pin the $\frac{1}{4}$ " sq x 36" balsa support to the plan in the position shown on the plan. Pin the wing back into position on the plan and support with the lower side up.



42...Trim $\frac{1}{4}$ " from one edge of $\frac{3}{32}$ " x 3" x 30" balsa sheets to make it $2\frac{3}{4}$ " wide. Save the $\frac{1}{4}$ " piece to make the cap strips later. Use this piece to sheet the lower leading edge as you did the top. Be sure that the wing is held flat so you do not induce a twist while installing this sheet.



43...Use the other 6" long piece from step 38 to sheet the inboard end of the wing between ribs B-1 and slightly past B-3. Trim the width to fit between the leading edge sheet and the trailing edge sheet. Glue into position.

44...Position and glue part B-10 into position on the first two B-4 ribs as shown. The wide edge faces outboard. Center it left and right with an equal amount of overhang on each end and glue it into position.



45...Cut $3/32$ " x $1/4$ " wide strips from the leading edge cutoff as cap strips and glue into position on top of the B-4, B-5 and B-6 ribs. The cap strips should be centered on the ribs except for B-6. The B-6 cap strip should be flush with the outboard face of the rib and extend inboard.

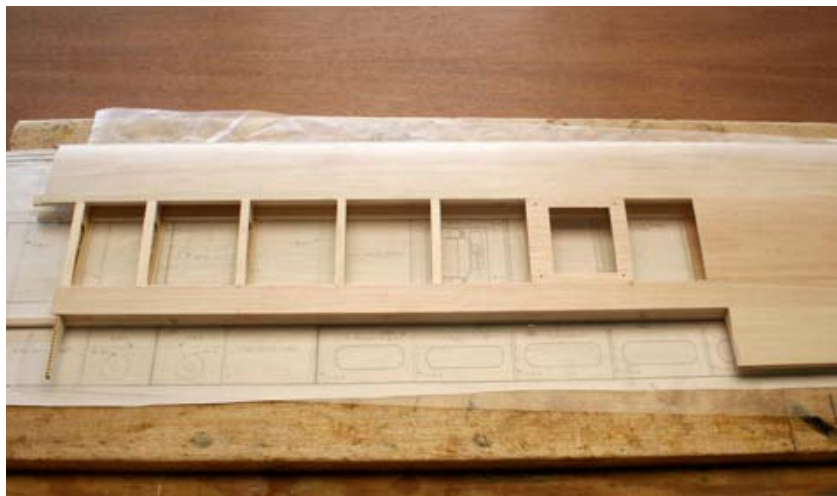

46...Remove the wing from the plan. Glue the B-11's into position on the inside of part B-10 in the locations shown on the plan. Align the holes in these parts with the holes in B-10.



47...Trim the sheet, spars & leading edge flush with the ribs on both ends of the wing. Sand the leading edge of the wing round to match the profile shown on the plan.



48...Glue the B-12 assembly to the outboard end of the wing. Sand it flush with the contour of the wing.



Sand the trailing edge and the edges of the wing tip round. **Leave the edges of the aileron and flap cutouts square.** Now sand the wing smooth all over.



49...Using the plan as a guide, mark the “N” strut block centerlines on the top of the wing just outboard of the B-5 rib.

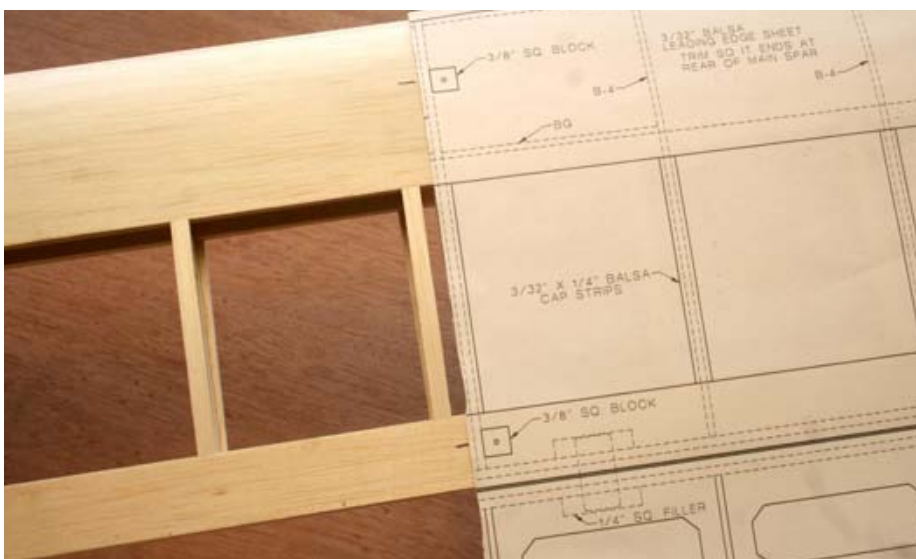

50...Using the 3/8" sq. blocks as a guide, cut square holes in the top sheet just outboard of rib B-5. The inboard edge of the holes should be flush with the outboard edge of the rib.



51...Glue the two strut blocks in place, flush with the top of the skin and against the rib.



52...Using the scrap from step 12, cut the four 1/4" sq. balsa aileron hinge supports to the length shown on the plan. Glue them into position, centered top and bottom, at the places shown on the plans, against the back side of B-9.

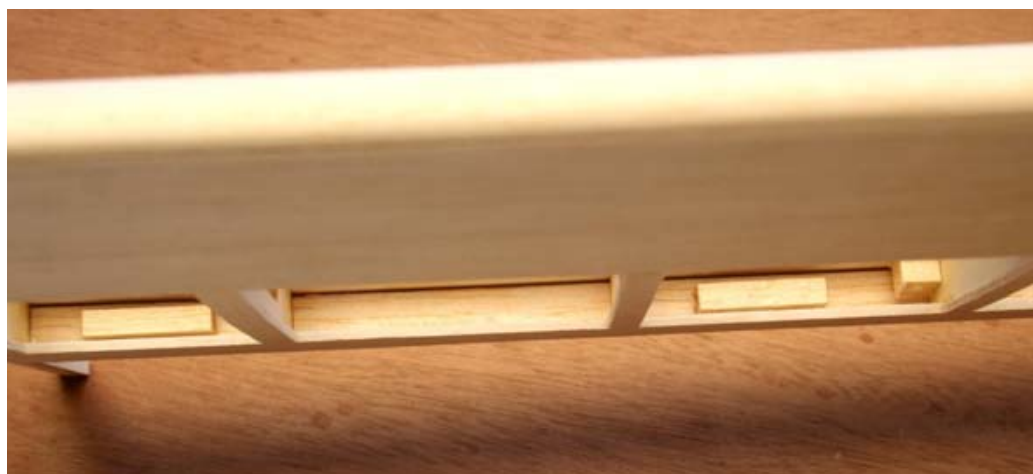

Repeat steps 12 thru 52 to build the Right wing.

Building the ailerons:

Build the right aileron.

53...Glue two A-1's together.



54...Sand or trim a small bevel on one edge of the A-1 assembly.



55...Glue the A-1 onto and flush with the front of A-2. The bevel on A-1 should be on the bottom so that the A-1's angle / lean slightly toward the trailing edge of the aileron..



56...Glue the (inboard) first and second A-3 ribs into position. They should be 90 degrees to A-2.

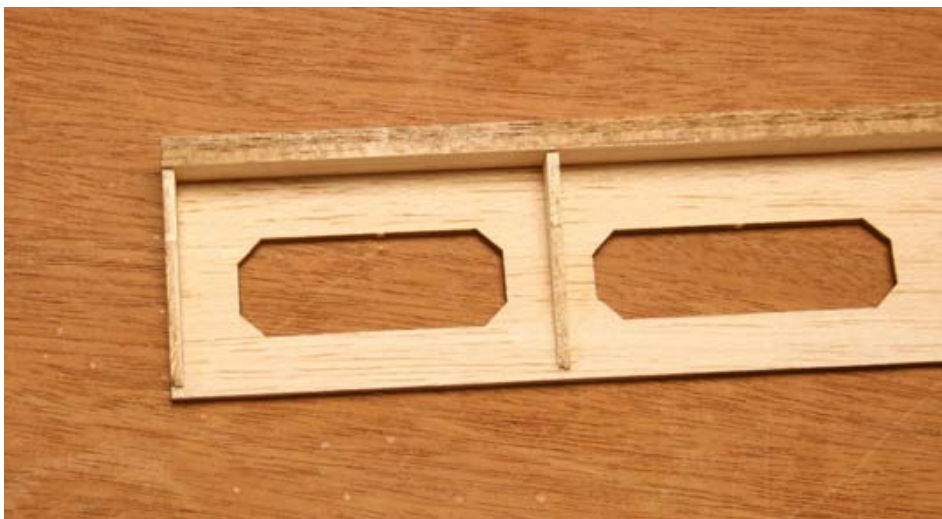

57...Place two A-4's into position against A-1 and A-3 and glue into place.



58...Glue the remaining A-3's into place.



59...Cut and glue four 1/4" sq. balsa fillers to the back of A-1 at locations of the aileron hinges.



60...Trim or sand an angle on the top of the A-1's to match the angle on the top of the A-3's.



61...Glue A-2 onto the top of the aileron. Sand the ends, front, top and rear of the aileron flush.



62...Draw a line centered on the front of the aileron. Draw a line 3/16" back from the leading edge on the top and bottom of the aileron.



63...Use these lines as a guide to trim or sand the proper angles on the front of the aileron as shown on the plan.



64...Mark a line centered on the back of the aileron spar (B-9). Mark the hinge locations and cut slots for the hinges in the wing and aileron. Temporarily install the hinges and check the aileron for proper fit on the wing. Do not glue the hinges at this time.



Repeat steps 53 thru 64 to build the left aileron.

65...Cut out the spar joiner hole in the B-1 ribs on the dashed lines as shown.

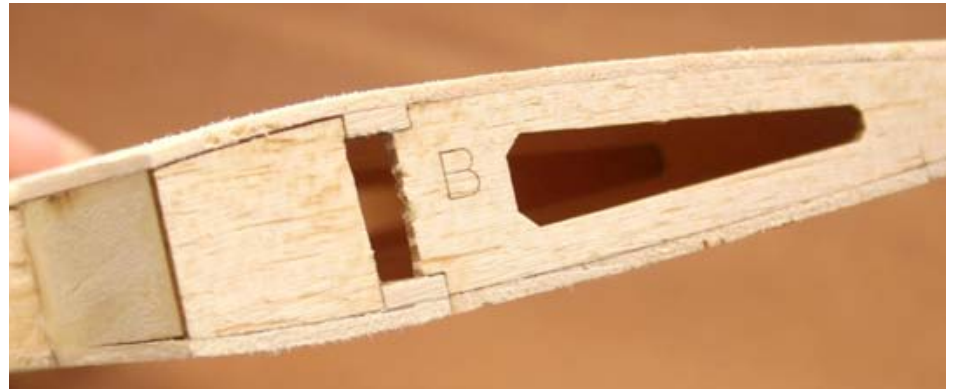

66...Insert the joiner into the wings and test fit the wings together.



Separate the wings and epoxy the joiner in one wing.

67...Join the wings using epoxy on the joiner and ribs. When the glue is dry, sand the joint smooth.

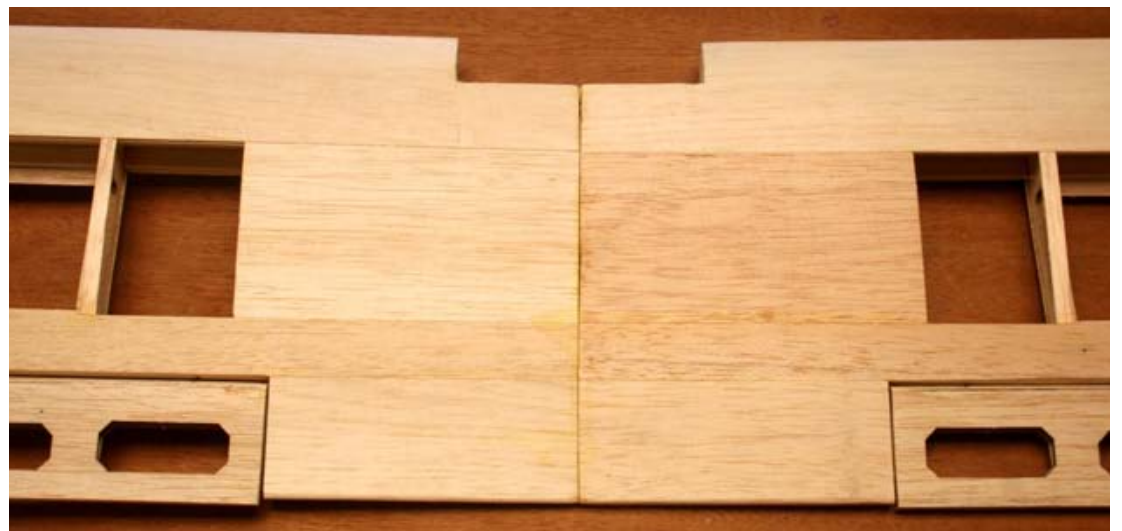

68...Cut the 2" dacron tap into two 10" pieces. Glue one piece of the 2" dacron tape into position on the bottom of the wing. Start at back end. Tack the back end down, centered on the joint. Now pull the tape tight and tack at the front. Now use thin C/A glue to attach the tape to the wing.

Use adequate ventilation.

When the glue is dry, Trim the tape flush with the front of the B-7's and the trailing edge.



69...Glue part B-15 into position on the top of the wing in the position shown on the plan. When the glue is dry, cut out the sheet and rib as shown for the aileron wires to pass through.

Sand the wing smooth all over.

Building the Top Wing:

70...Take two 1/8" x 3/8" x 36" bass spars and cut a piece 8-1/2" long from each one to make the center section spars. Check the length against the plan before cutting.



71...Cut the two long pieces from the previous step and another two 1/8" x 3/8" x 36" strips to make four pieces 1/8" x 3/8" x 26" long.



72...Using part G-1 as a guide, cut the angle on one end of each of the 1/8" x 3/8" x 26" main spars from the previous step. The end of G-1 with the small "X" is the end with the angle.

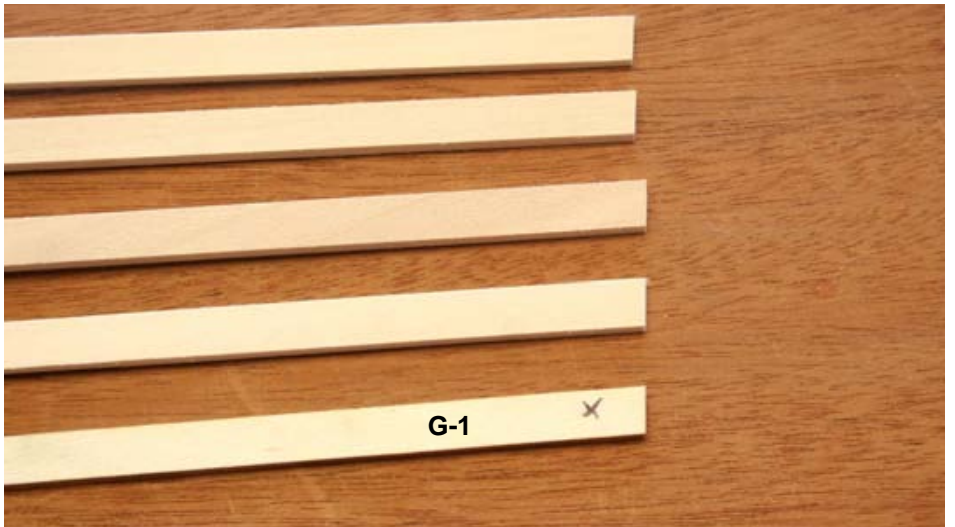

73...Cut four 3/32" x 3" x 36" leading edge sheets to a length of 26". Save the cutoff pieces.



74...Using part G-2 as a guide, cut the angle on one end of each of the leading edge sheets from the previous step. The end of G-2 with the small "X" is the end with the angle.

75..Cut four 3/32" x 1" x 36" trailing edge sheets to a length of 26". Save the cutoff pieces.

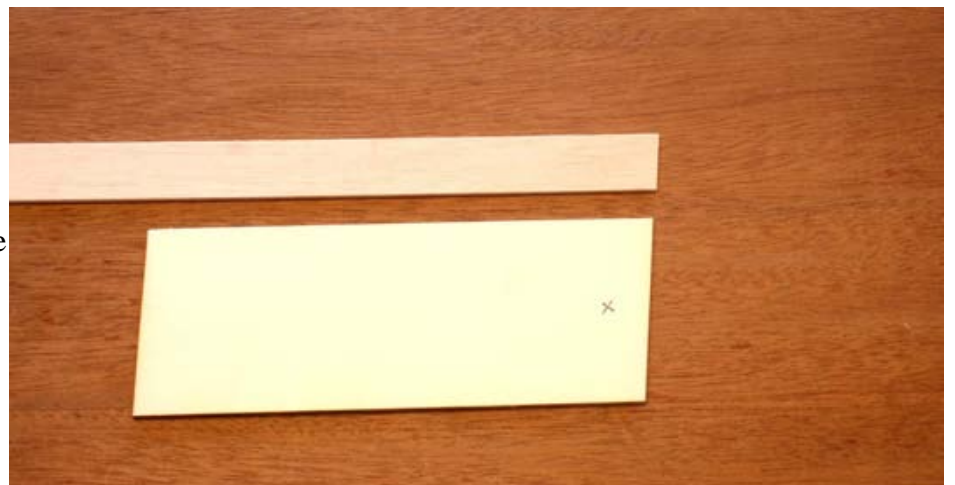

76...Using part G-2 as a guide, cut the angle on one end of each of the trailing edge sheets from the previous step. The end of G-2 with the small "X" is the end with the angle.

Building the center section:

77...Glue the four T-7's to the four T-8's as shown. Use the markings on the T-8's as a guide for the proper position.

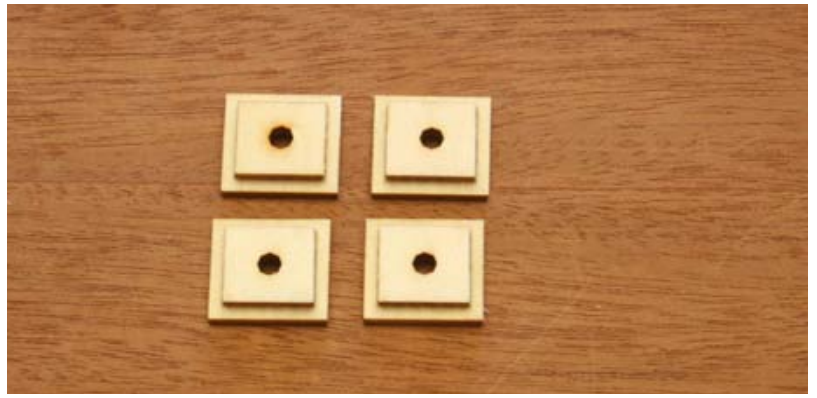

78...Press the four 6-32 blind nuts into place in the T-7 / T-8 assemblies. The blind nuts go into the T-7 side. Secure the blind nuts with a small drop of thin C/A glue.

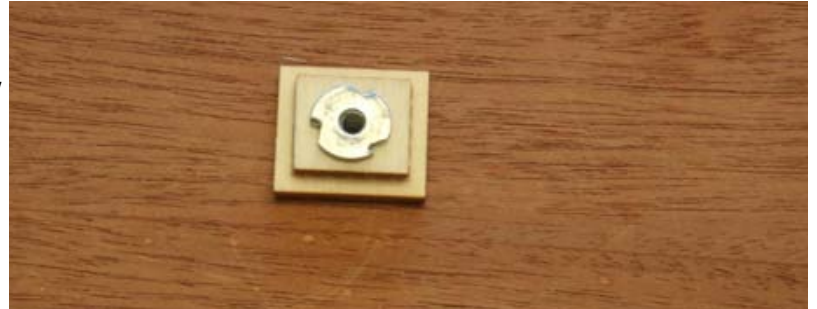

79...Glue the seven T-12's together as shown.



80...Place parts T-3, T-4, T-5 and T-6 into position on one of the T-1 ribs. Tack glue them into position, 90 degrees, to the T-1 rib with a small drop of thin C/A glue. The picture shows the left hand assembly.



81...Place rib T-2 into position on the assembly. Tack glue with small drops of thin C/A glue.



82...Press two of the T-7 / T-8 assemblies into position on the rib assembly as shown. Make sure that they are completely seated. Now completely glue all joints in the assembly with several applications of thin C/A glue. This completes the left hand assembly.



83...Make the right hand T-1 / T-2 assembly opposite of the previous left hand assembly.

Be sure that one is left hand and one is right hand.



84...Glue the T-9's and the T-10's to the inside face of the T-2 ribs as shown.



85...Assemble the lower spar on the plan. Pin one 8-1/2" bass strip from step 70 in the center. Pin and glue the two outer spars from step 72. The angles on the outer spars butt up against the center piece. When the glue is dry, position and glue the top joiner (T-Joiner) into place.

86...Pin the lower main spar into position on the top wing plan. The joiner should be on the top. The ends will be long and extend past the T-16 rib.



87...Position the left and right T-1 / T-2 assemblies on the main spar and glue them to the spar..

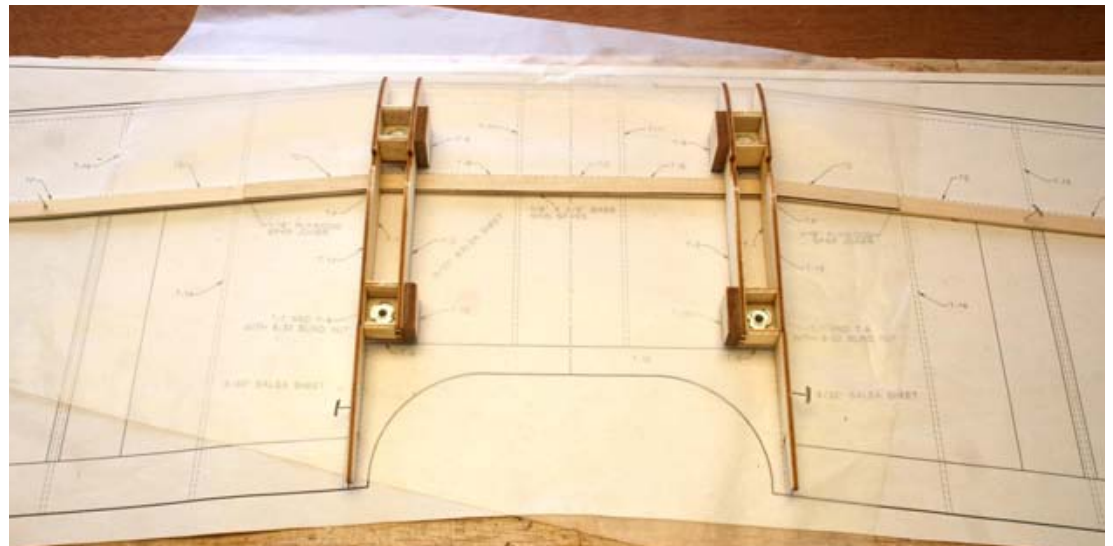

88...Pin the ribs T-11 in place and glue to the main spar.

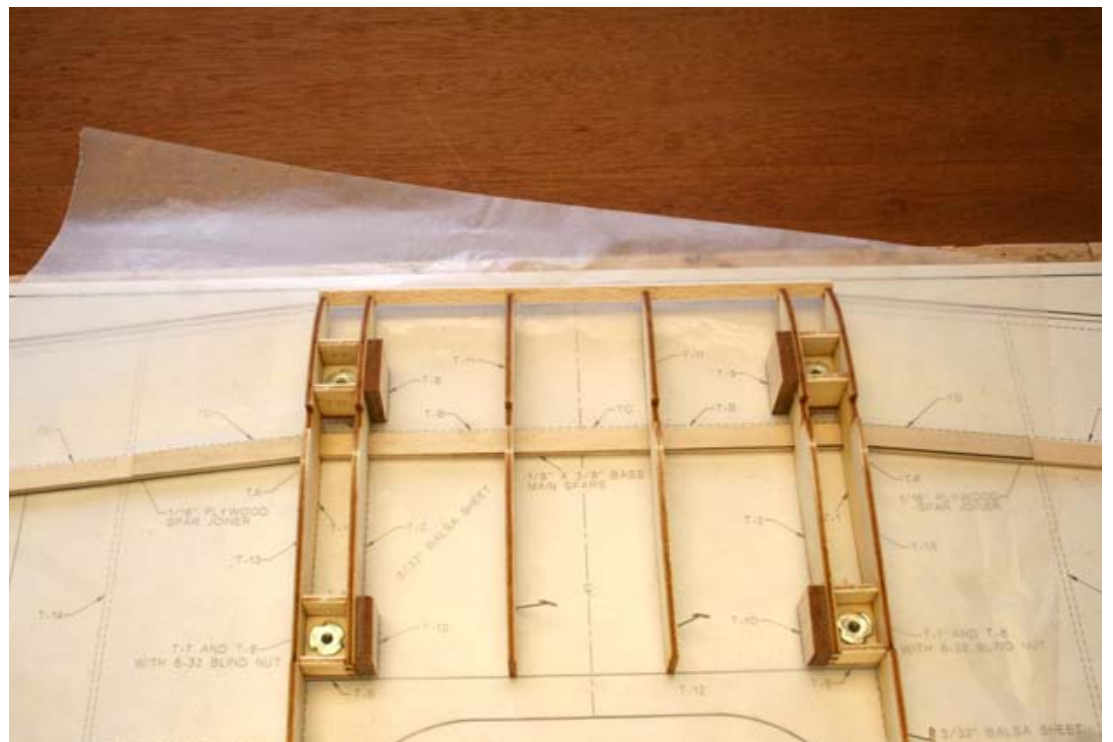

89...Cut a piece 8-1/2" long from one of the 1/4" sq. x 36" strips and glue in position on the leading edge of the ribs.



90...Glue the remaining 1/8" x 3/8" x 8-1/2" from step 70 to the other top joiner. Use the plan as a guide to center the spar on the joiner.



91...Glue the top center spar and spar joiner into position. The joiner is on the bottom.



92...Glue the shear webs T-A, T-B, and T-C into position on the front of the main spars.



93...Glue the T-12 assembly into position.



94...cut two pieces 8-1/2" long from one of the 3/32" x 4" x 24" sheets. Use these pieces to sheet the top of the center section. The sheet goes over the main spar and butts against the front of the T-12's.



Building the Right Side of the Top Wing:

95...Glue the T-13, T-14, T-15 and T-16 ribs into position on the lower spar. They should be 90 degrees to the building board.



96...Glue the top main spar into position on the ribs and the spar joiner. Squeeze the joiner against the spar to make sure that they are securely bonded together.



Glue the 1/4" sq. leading edge into place on the front of the ribs.

97...Glue shear webs T-D through T-I into position on the front of the main spars.



98...Slide the 3/32" x 1" lower trailing edge from step 76 into position in the slots in the back of the ribs. Make sure that it is fully seated in the slots and the angled end is against the center section. When properly positioned, glue the bottom trailing edge in place.



99...Glue the top 3/32" x 1" trailing edge into position. The angled end goes against the center section.



100...Trim 1/4" from one of the leading edge sheets from step 74 to a width of 2-3/4" as you did for the lower wing. Save the 1/4" cutoff.

101...Glue the leading edge sheet in position as you did the lower wing. The angled end goes against the center section.



102...Cut pieces from the 3/32" x 4" x 24" balsa to sheet the inboard end of the wing as shown. You can use part G-2 to trim the angle on inboard end of these pieces of sheet.

103...Cut, fit and glue the 3/32" x 1/4" cap strips on the top of each rib as you did the bottom wing.



Building the Left Side of the Top Wing:

104...Repeat steps 95 through 103 to build the left side of the top wing.

105...Remove the wing from the plan and turn it over. Remove the support tabs from the back edge of the ribs.

Place the 3/8" sq. x 36" jig under the trailing edge in the position shown on the plan. Pin the outboard panel securely to the jig and the plan.

106...Use 3/32" x 4" balsa to sheet the top of the center section as you did the opposite side in step 94.



107...Cut the bottom sheet away from the four T-7 / T-8 locations as shown.



108...Glue the leading edge sheet, inboard end sheet and cap strips to both outer panels as you did the top side.

109...Trim the spars and sheet flush with the T-16 ribs.

110...Glue the two pairs of T-17 wing tips to each end of the wing.

Repeat steps 108-110 to finish the bottom of the other side of the wing.



111...Sand the trailing edge and the edges of the wing tip round. Sand the T-12's flush with the wing skins and sand the rear edge of it to shape. Sand the leading edge round to match the plan.



112...Cut two 20" pieces the 1" dacron tape. Glue one piece of the 1" dacron tape into position on the top and bottom on each joint of the top wing. Start at back end. Tack the back end down, centered on the joint. Now pull the tape tight around the front and back to the trailing edge on the opposite side. Now use thin C/A glue to attach the tape to the wing.

Use adequate ventilation.

When the glue is dry, Trim the tape flush with the trailing edge and trim away from the T-7 / T-8 holes.

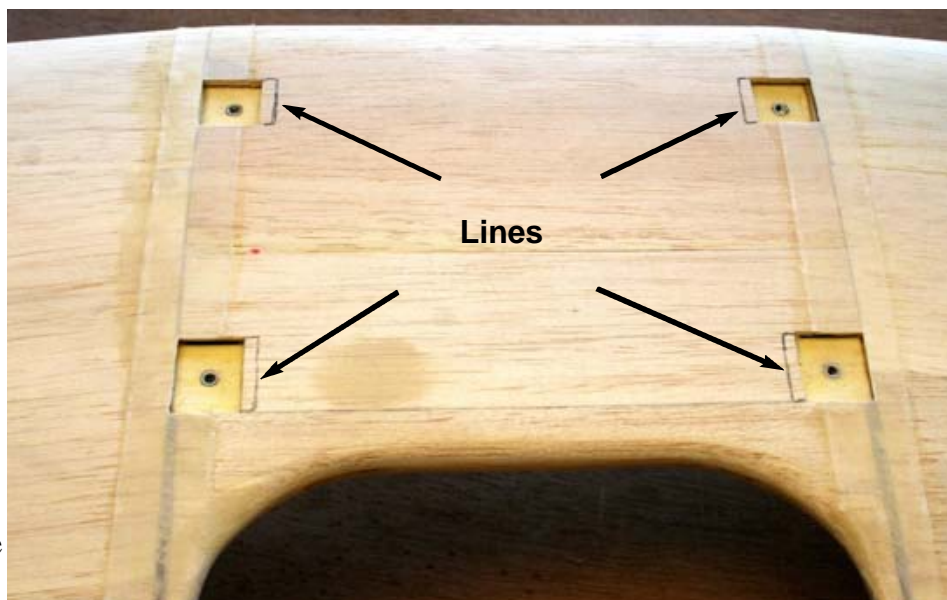

113...Mark a line on the sheet 1/4" from the inboard edge of the T-7 / T-8 holes.

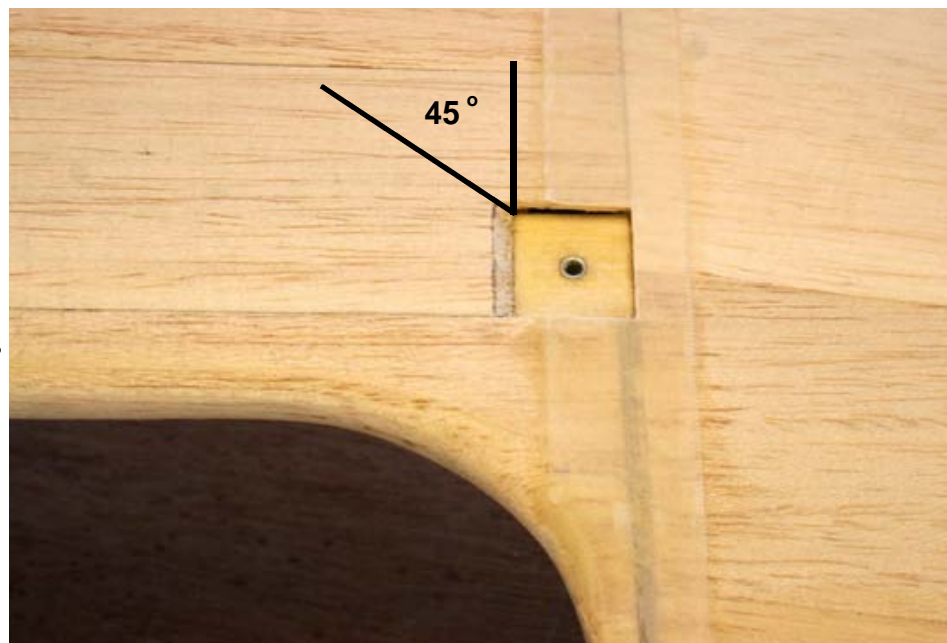

114...Trim a 45 degree bevel in the wing sheet, T-9s and T-10s from the marked lines to the edge of T-8 as shown.

Now sand the wing smooth all over.

Building the Fuselage:

115...Glue F-1L and F-2 together.
Glue F-3L and F-4L into position as shown. This makes the left fuselage side.

Be sure to position the parts as shown to make the left side.

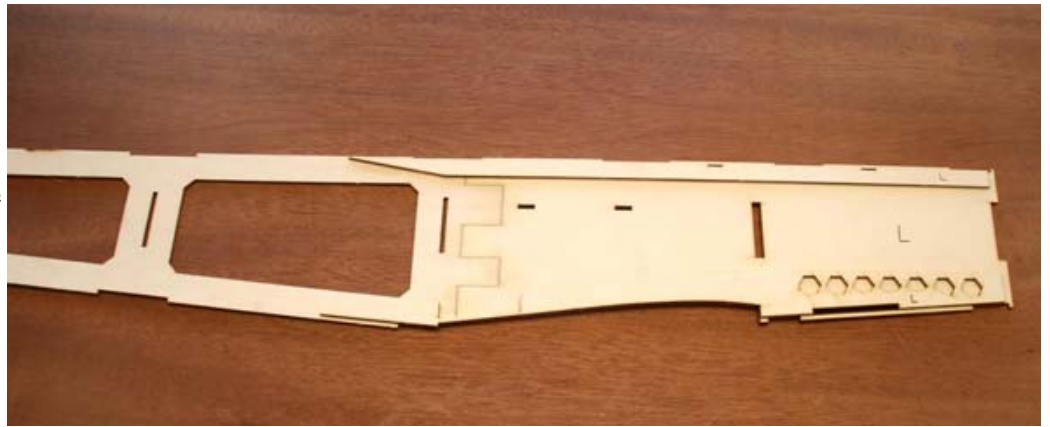

116...Glue F-1R and F-2 together.
Glue F-3R and F-4R into position as shown. This makes the right fuselage side.

Be sure to position the parts as shown to make the right side.



117...Glue the two F-5's together.
Glue the two F-12's together. Glue the two F-16's together.

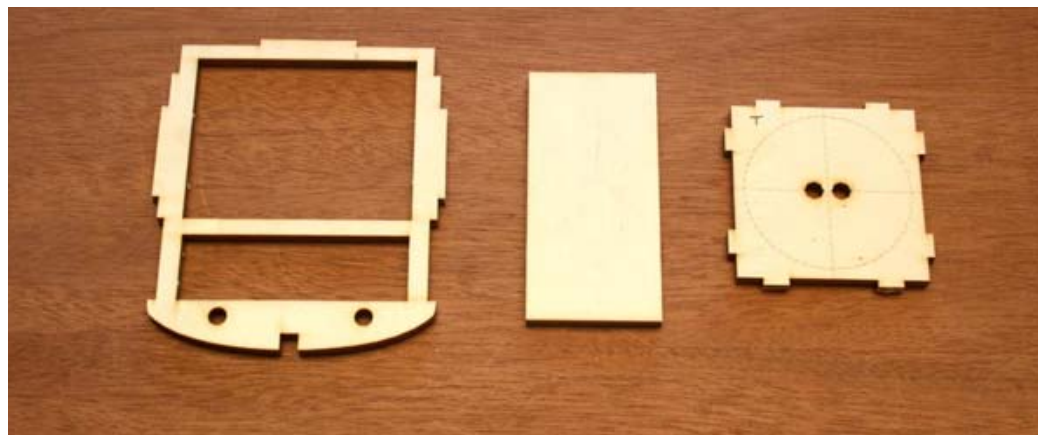

118...Glue F-6A and F-6B to F-6 in the positions marked. Cut and glue the 1/4" sq. braces to the front of formers F-7 and F-9

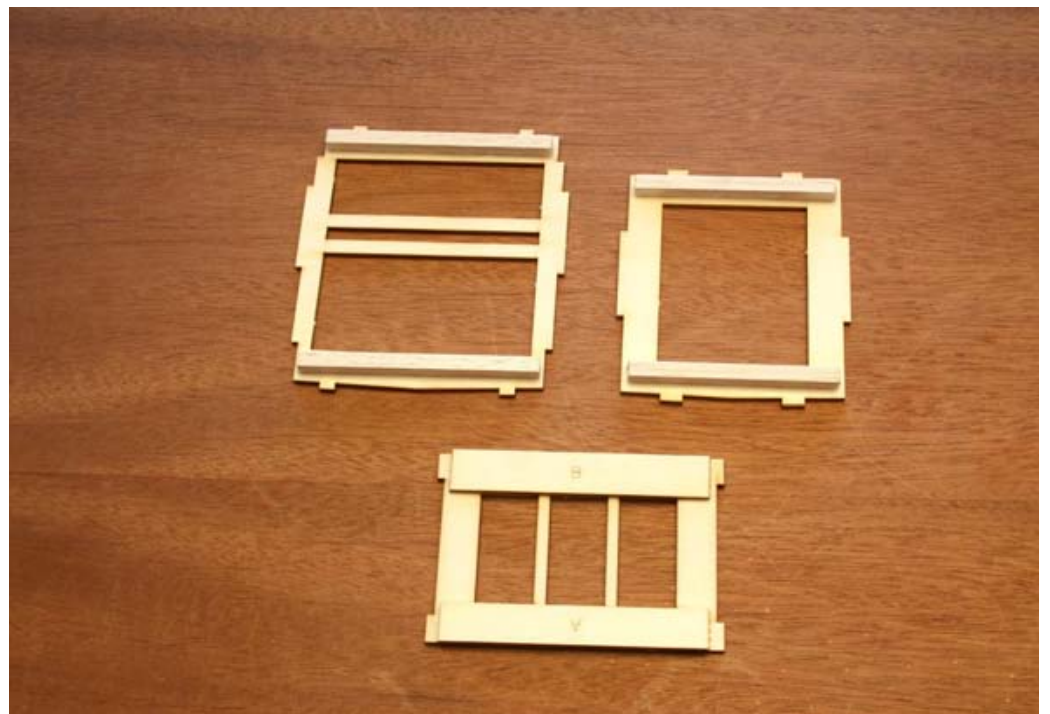

119...Glue F-13B to the back of F-13A.

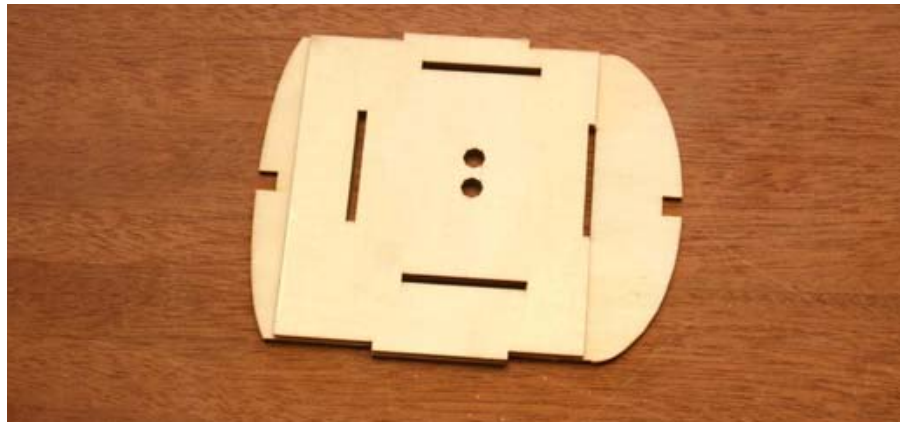

MOTOR LENGTH NOTE: We use a built up box to mount the motor on the model. This box is sized for the O.S. 65AX that we used in the prototype model. The length of your power system will probably be different.

Measure your motor + propeller + mount against the plan. If your measurement matches the plan you can continue on to the next assembly step. If your measurement is shorter, you can add birch plywood spacers between the mount and F-16.

If your measurement is longer than required, you can shorten the box. If you shorten the box by trimming off the back end, fill in the slots in F-13 with scrap plywood and glue the box to the front of F-13. Then use 1/4" sq. balsa reinforcements in the corners between the box and F-13.

You can also not use the box and use birch ply spacers between F-13A and the back of the mount. For the longest motors, you can bolt the mount directly to F-13.

If you do this, fill in the slots in F-13A/B with scrap ply and drill the mount holes directly in F-13.

120...Place your motor mount on the front of F-16(or spacers) and align with the marked centerlines. Using the motor mount as a guide, drill the mount holes in F-16 as shown. Use a drill that fits the holes in the motor mount. Remove the motor mount and open up the holes in F-16 to 3/16" Dia.



121...Press the 6-32 blind nuts into the mount holes in the **back** of F-16. Secure them in place with thin C/A Glue.



122...Tack glue the F-14's and F-15's together to make the motor mount box. Press the box into the slots in F-13 as shown. Be sure that it is fully seated and glue the box securely to F-13 and completely glue the F-14's and F-15's together.

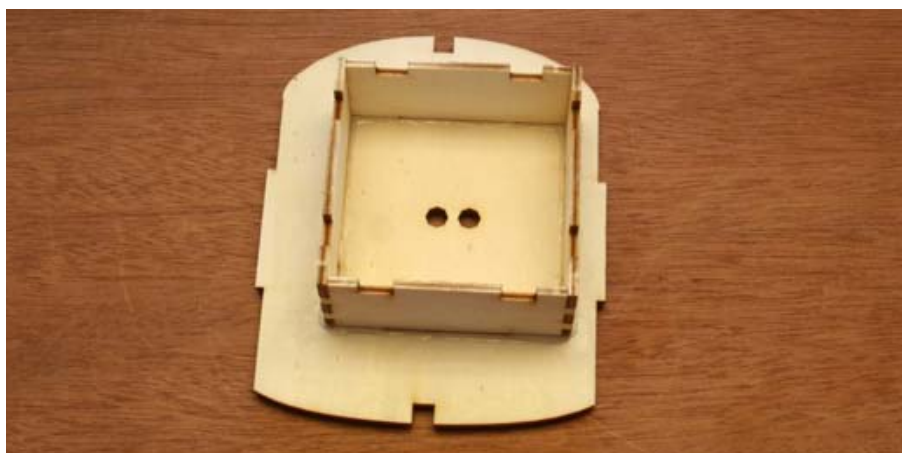

123...Securely glue F-16 to the front of the motor mount box.

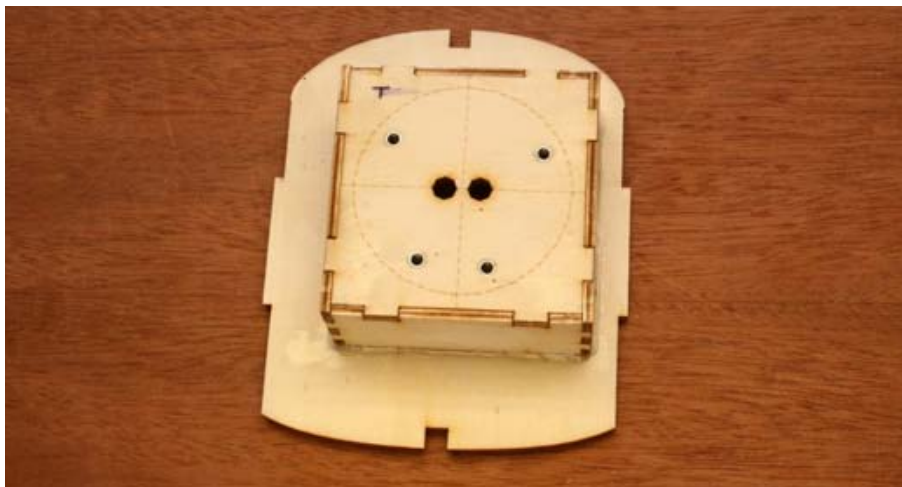

124...Glue the two F-17B's together on top of F-17A as shown. Line up the marked "X" on the parts as shown.

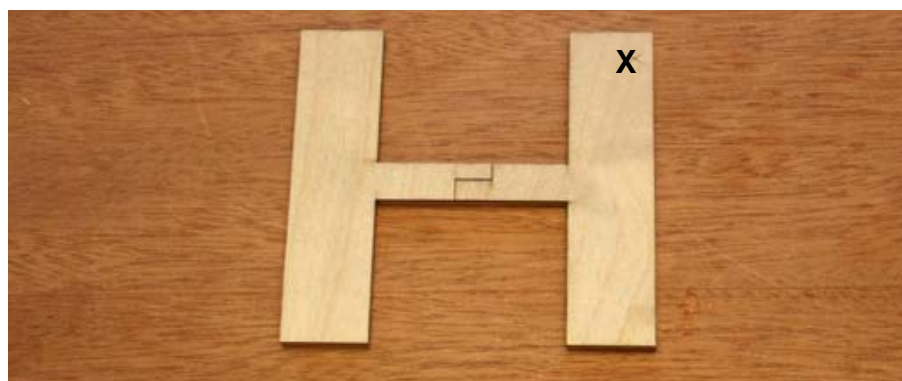

125...Glue this assembly onto F-17 at the marked locations. Line up the marked "X" on the parts as shown.

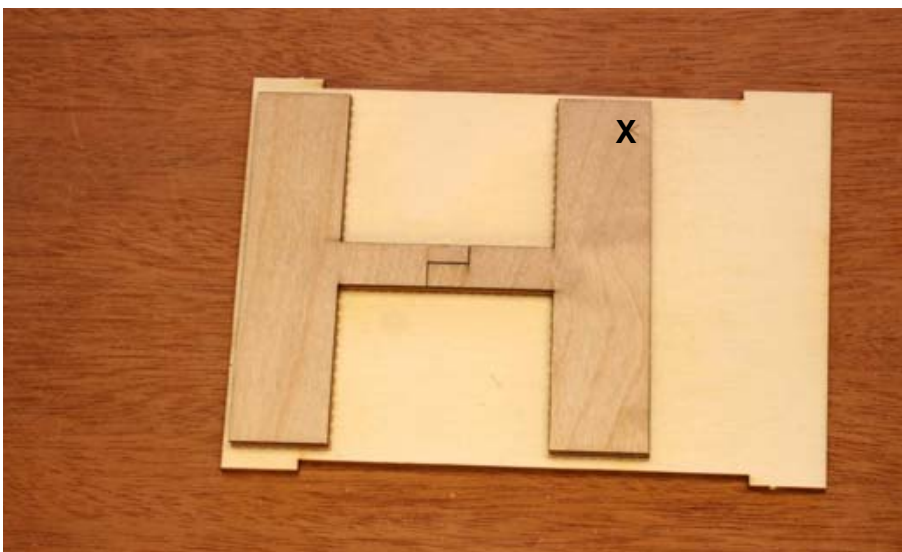

126...Glue F-17C on top of F-17B as shown. Do not allow excess glue to get into the pockets between F-17C and F-17. Line up the marked "X" on the parts as shown.

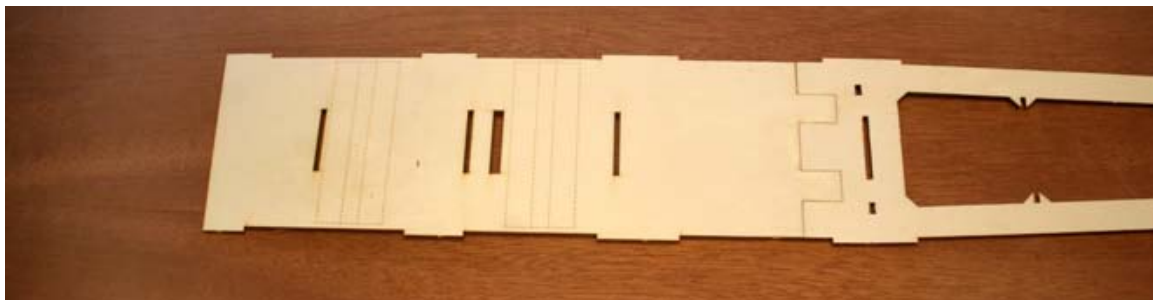
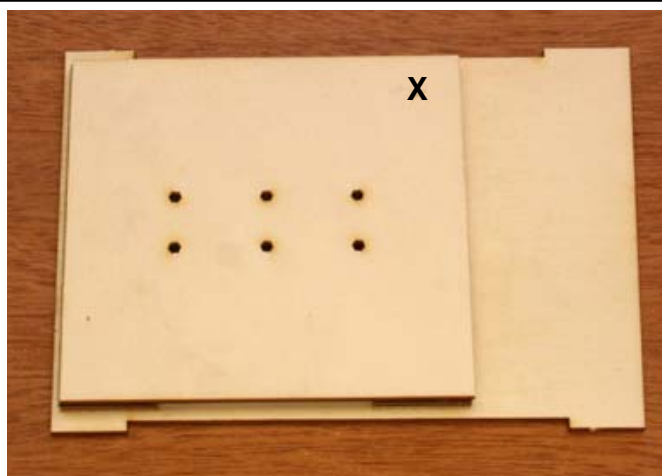

127...Glue parts F-10 and F-11 together as shown.

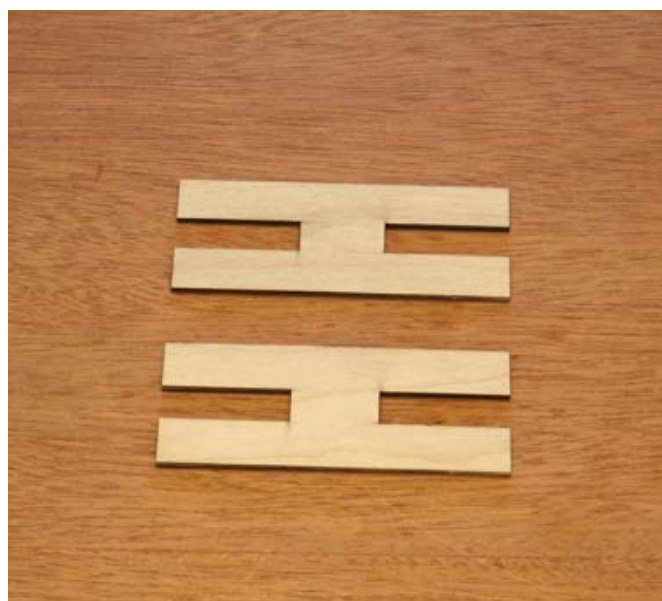

128...Glue the two F-10A's to the two F-10B's. One F-10A on each F-10B.

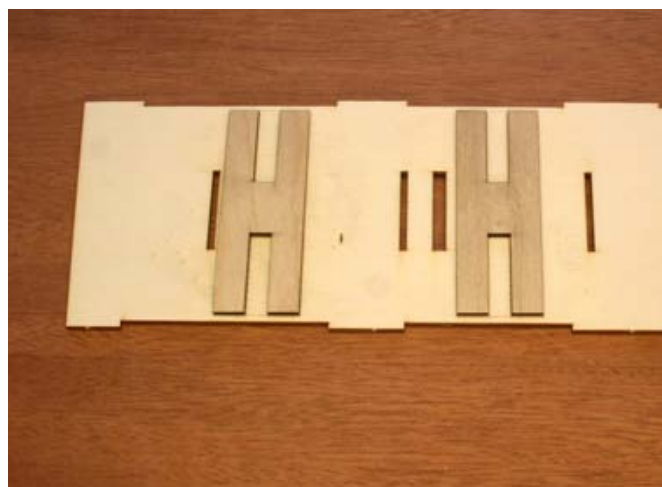

129...Glue these parts to F-10 at the marked locations.

130...Glue parts to F-10C on top of the F-10B's as shown.

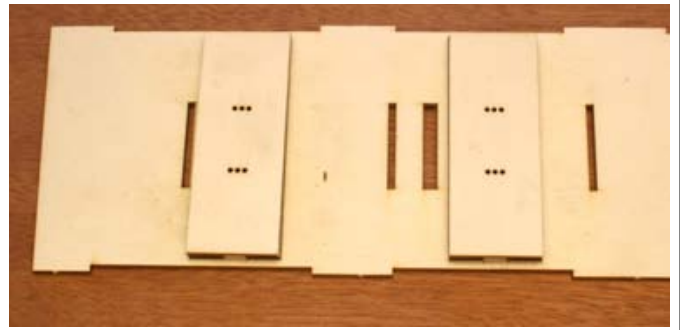

131...Position formers F-5, F-6 and F-7 onto the right fuselage side. They should be fully seated and 90 degrees to the fuselage side. The 1/4" sq. braces on F-7 should face the rear. The doublers on F-6 should be on top with "A" at the front and "B" at the rear. When properly positioned, glue the formers in place.

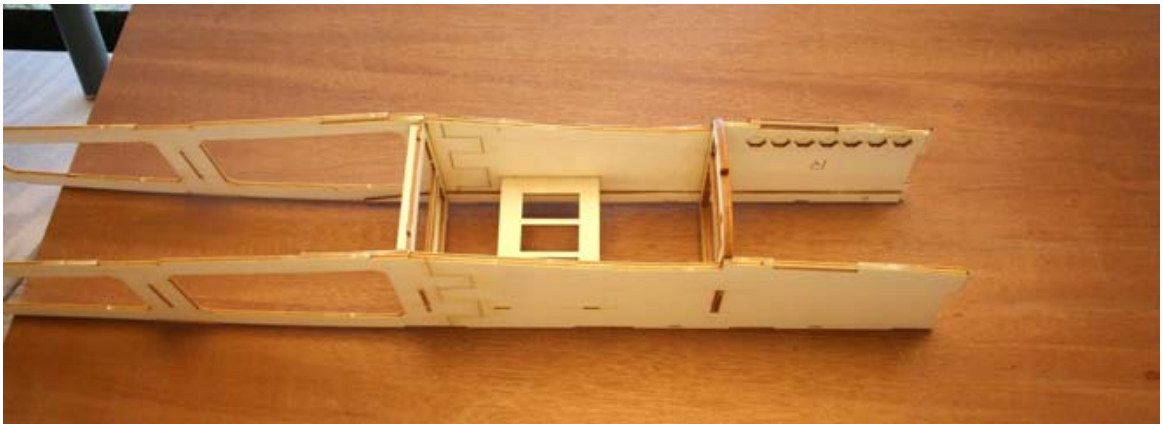

132...Put the left fuselage side into position. Seat the formers completely and square up the fuselage. When properly positioned, glue the formers in place.

133...Place former F-8 into position and pull the rear of the fuselage sides together. Adjust the back end until the fuselage is straight and square. Glue the fuselage sides together and glue the former in place.

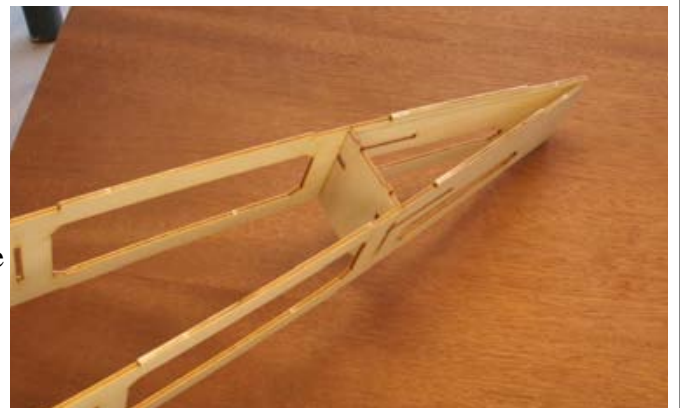

134...Glue former F-9 into position and glue in place. The 1/4" balsa braces should be on the front side.

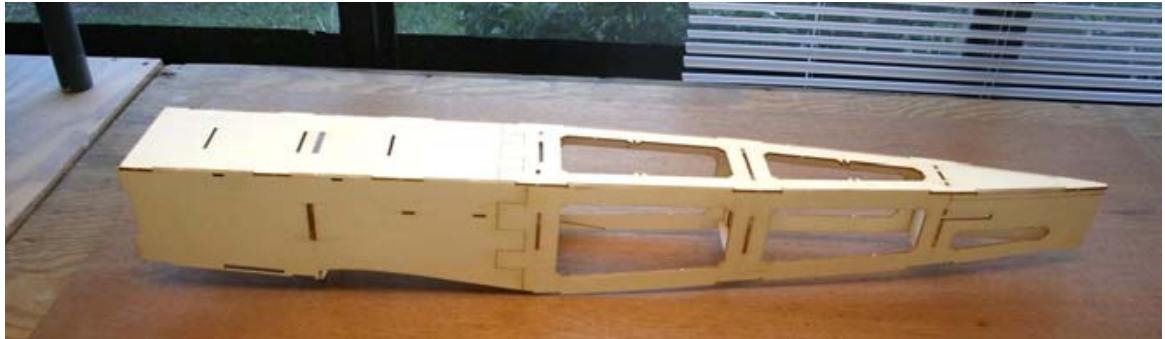
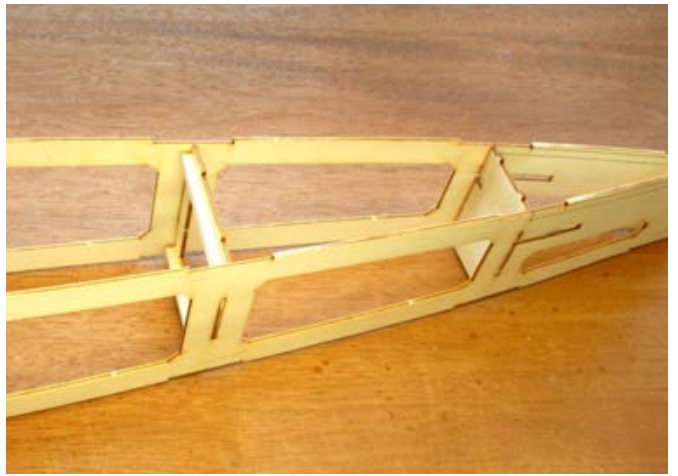

135...Glue F-10 / F-11 into position on the top of the fuselage. Spread and squeeze the sides as required to get F-10 to fit in the proper position.



136...Glue F-18 into position on the bottom of the fuselage. Spread and squeeze the sides as required to get F-18 to fit in the proper position. Gently crack it on the dashed line so the front end fits flat on the bottom of F-7.

137...Securely glue the F-12 assembly into place in the notches in the back of the F-3 doublers. Glue to the fuselage sides and F-7. Cut and glue a 1/4"x 2" brace under F-12 in the corner between F-12 and F-3 on each side of the fuselage.



138...Place the bottom wing onto the fuselage. Sand the back end of the wing if required to achieve a good fit with the front of the wing tight against F-5 with the wing completely seated in the wing saddle.

Center the wing left and right on the fuselage. Hold it tightly in position against F-5, and using a 3/16" drill bit, drill the bolt holes in the wing and parts F-12 in the fuselage. The drill bit must be 90 degrees to the bottom surface of the wing so the bolt heads will sit flat.



139...Remove the wing from the fuselage. Using a 1/4" drill bit, drill out the wing bolt holes in the **wing only**.

Place the wing back on the fuselage. Use a 1/4-20 tap to cut threads in the holes drilled in F-12. Apply some thin C/A to harden these threads and when the glue is dry, re-tap to clean up the threads.

Use the two 1" nylon bolts to attach the wing to the fuselage.



140...Remove the bolts. Center parts B-13 over marks for the wing bolts and glue into position. Put the bolts back in place. Make sure that the front of the wing is centered and tight against F-5.



141...Center the wing left and right on the fuselage. **Hold the wing tightly against the fuselage.** Use a 1/4" drill bit to drill holes through F-5 into the front of the wing. Be sure that the holes are square, left and right and up and down to F-5.



142...Remove the wing from the fuselage. Insert the 1/4" dowels into the holes in B-7. They should stick out 3/8". Securely glue the dowels into position.



143...Install the wing back on the model and make sure that it fits properly. Now remove the wing.



144...Install part F-13 onto the front of the fuselage. Make sure that it is tightly in place and fully seated. When properly positioned, glue it in place.

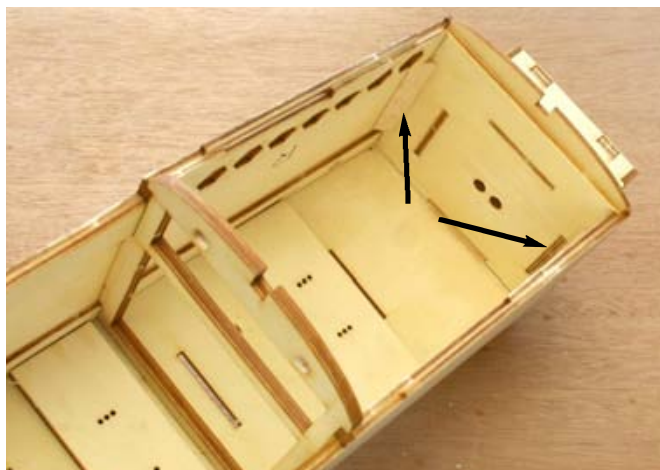

Cut two pieces of 1/4" triangle and glue into the corners as shown.

145...Fit part F-19 into the fuselage. The sides should be tight against the top of the F-3 doublers. The front is tight against F-13 and the back edge rests on top of the cross piece of F-5. When properly positioned, glue it in place.



146...Glue the F-17 assembly onto the fuselage as shown.



147...Glue parts F-22, F-23 and F-24 to part F-10. They should be 90 degrees to F-10. When the glue is dry, cut, fit and glue a piece of 1/4" sq. balsa in place from F-24 to F-13 as shown.



148...Cut two pieces of 3/32" x 4" balsa to a length of 9-1/2". Position and fit one of the sheets against the top edge of the fuselage, just touching the formers. It is longer than needed and will extend past the formers slightly. Sand or trim to get a good fit against the fuselage if needed, and then glue the sheet to the fuselage side only.



149...Moisten the outside of the sheet with an ammonia based window cleaner such as Windex. Roll the sheet around the formers. Trim it so that it ends at the centerline of the 1/4" sq. stringer. Glue the sheet into place. When the glue is dry, trim the front and rear flush with the formers.



150...Fit and glue the other sheet on the opposite side as you did the first. When the glue is dry, trim the front and rear flush with the formers.



151...Glue parts F-20 and F-21 to part F-17. They should be 90 degrees to F-17. When the glue is dry, cut, fit and glue a piece of 1/4" sq. balsa in place from F-5 to F-13 as shown.



152...Cut, fit and glue 3/32" sheet on the forward bottom fuselage as you did the top.



153...Install the motor and mount.

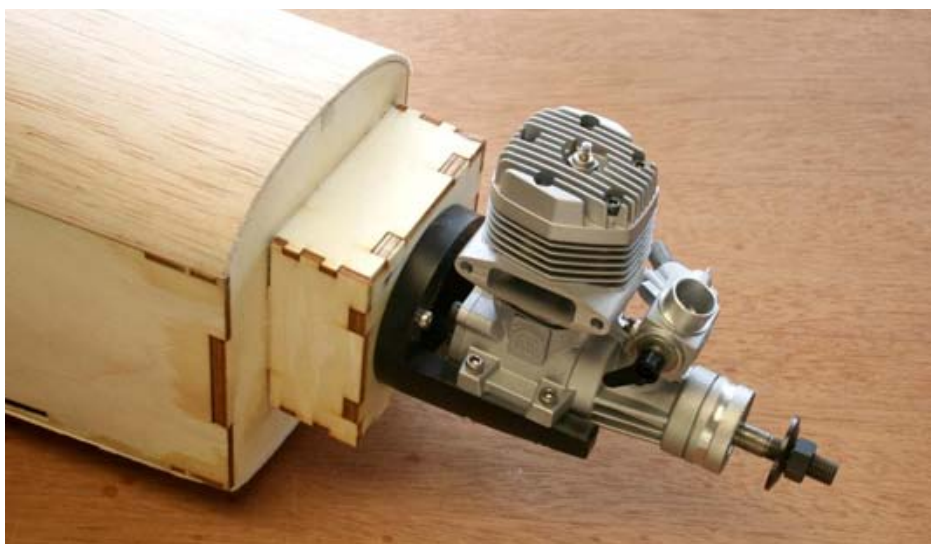

154...Cut four strips (spacers) from some scrap 3mm plywood. Tack glue them to the front of F-32 as shown.



155...Place the spinner backplate on top of the spacers. center it over F-32 and tack glue the backplate to the spacers.



156...Bolt the spinner back plate on the motor. Use some washers as spacers to take the place of the propeller.

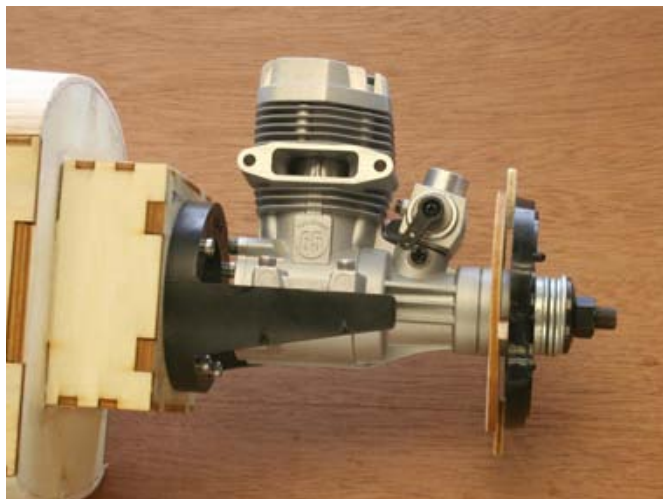

157...Cut the 1/4" x 2" x 36" balsa sheet into six 6" lengths.



158...Glue these pieces together to make three pieces 1/4" x 4" x 6" as shown.



159...Trim angles on the ends of one of the 1/4" x 4" x 6" pieces so that it fits in the bottom of the fuselage between F-13 and F-32. The piece should be centered on the fuselage at F-13. The 1/4" sheet should not be flush at the front and back ends, but it should stick up about 1/8" from the bottom fuselage sheet and F-32. See the plan and the pictures in the next step for this detail. When properly positioned, glue the 1/4" sheet in place.

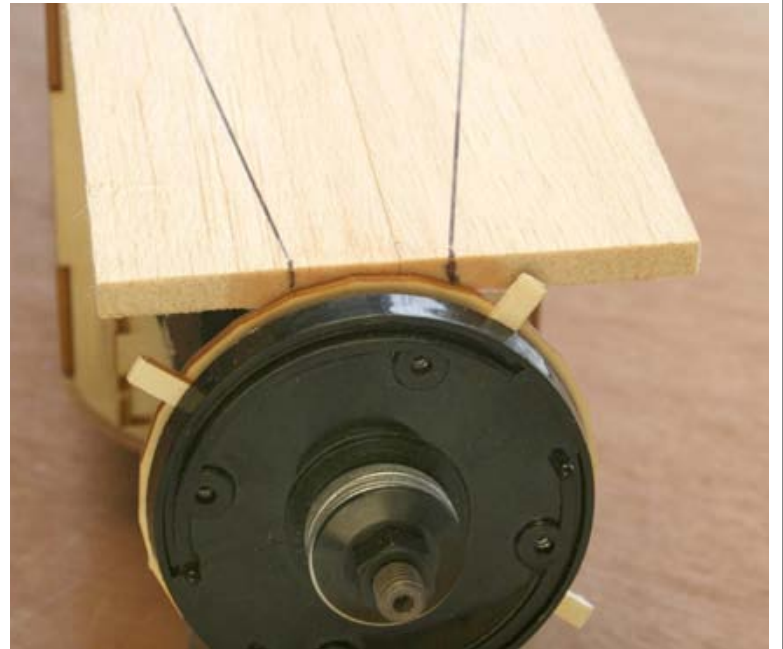
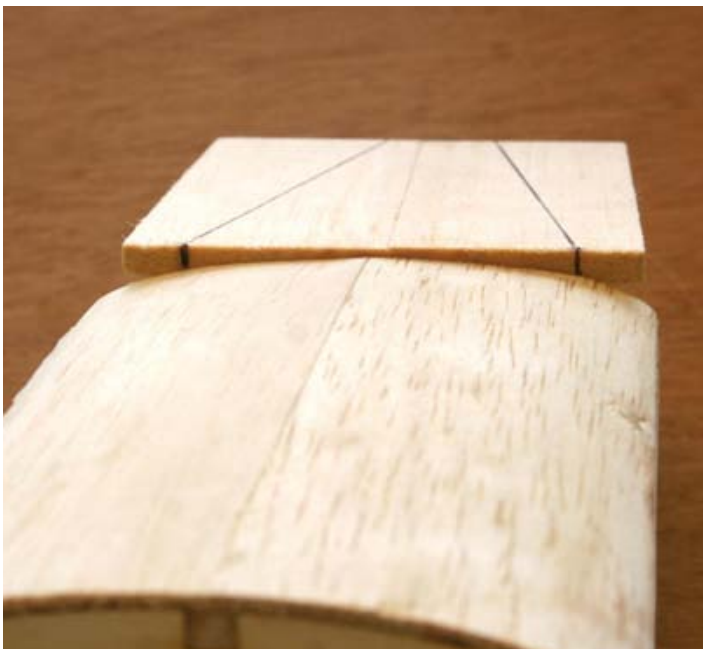
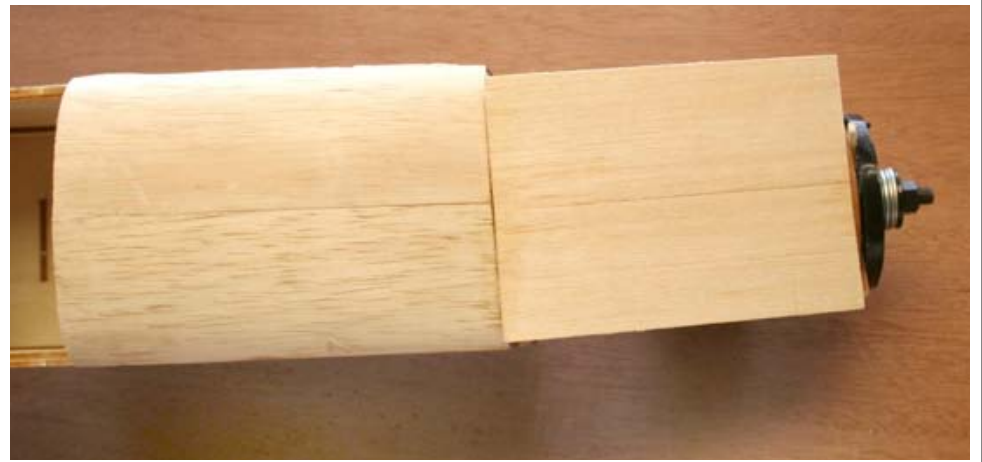
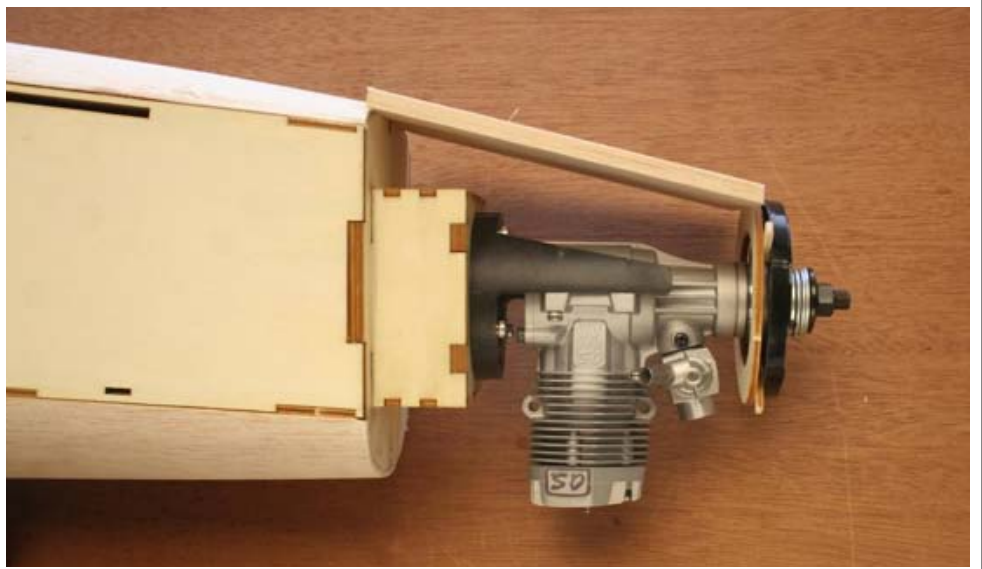

160...Mark vertical lines on the end of the 1/4" sheet as shown. These lines should be about 3/32" inboard of the point where the inside face of the 1/4" sheet starts overhanging the fuselage and F-32. Draw lines on the bottom of the 1/4" sheet connecting the vertical lines on each end.

161...Cut the 1/4" sheet on the lines as shown.



162...Trim angles on the ends of two of the 1/4" x 4" x 6" pieces so that they fit in the side of the fuselage between F-13 and F-32. The pieces should be centered on the fuselage at F-13. The 1/4" sheet should not be flush at the front and back ends, but it should stick up about 1/8" from the fuselage sides and F-32 as you did on the bottom. When properly positioned, glue these 1/4" sheets in place.



163...Mark the front end of the side sheets as you did the bottom. Draw lines connecting the front lines with the back corners and then cut the sheet as shown.



164...Cut pieces from the left over 3/8" sq. wing jig to fit against the edges of the 1/4" side sheet on each side of the bottom and side of the fuselage. You will have to trim a bevel on the edges of the 1/4" sheets to allow the 3/8" sq. strips to fit tightly against them.

It is hard to trim and fit all of these pieces perfectly, so don't worry if you end up with some gaps between the parts. Just cut small pieces of scrap balsa to fill in the gaps. Let the parts and fillers stick out a little bit and everything will be smooth after you sand the nose to shape.



165...Cut a piece of 1/4" sheet to a long triangle shape and glue in place between the 3/8" sq. pieces. You will need to bevel the edges to get a tight fit. Again...you will probably end up with some gaps. Just fill them with scrap pieces of balsa.

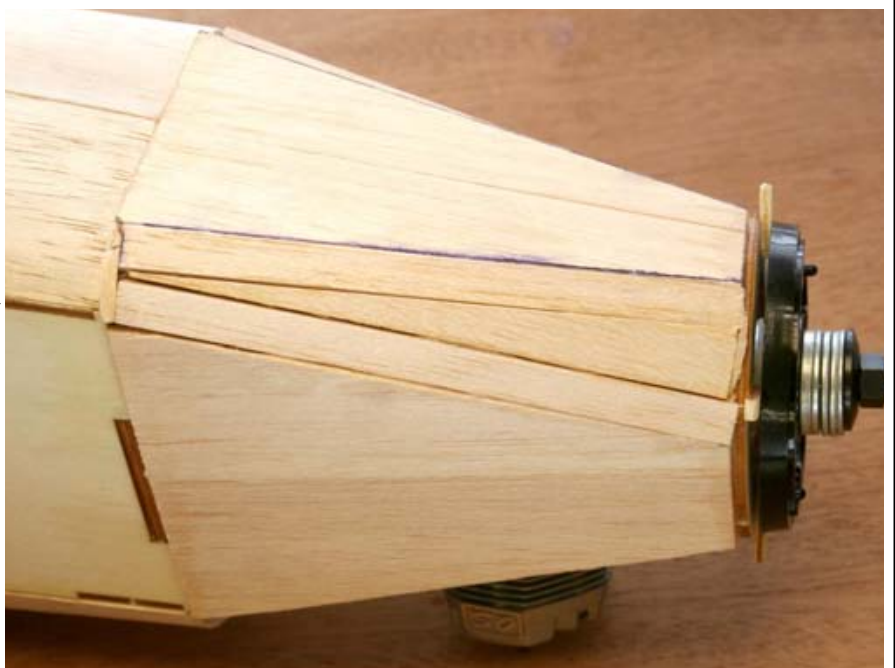

166...Remove the motor. Trim the spacers away from the front of F-32.



167...Buildup the sides and top on the top of the fuselage with 1/4" sheet.

168...Sand the nose of the fuselage to shape and smooth. You want to sand the balsa sheet to gently curve between F-13 and F-32. Fill any large gaps with scrap balsa. Small gaps can be filled with model balsa filler.



169...Install the motor on the model. Trim away the balsa on the sides of the motor to provide clearance for the muffler and needle valve. Mount the propeller and spinner and check for proper clearance. Drill a 1/4" drain hole at the back of the bottom cowl sheet in the location shown on the plan.



170...Position and glue formers F-25 through F-29 on the back of the fuselage. They should be 90 degrees to the top of the fuselage.



171...Glue the 1/4" sq. top stringer into place in the notches in the formers. Glue the 1/8" x 1/4" sq. side stringer into place in the notches in the formers. When the glue is dry, trim the ends flush.



172...Glue part F-24A to the back of F-24. There should be an equal step all the way around the top edge. Glue part F-2A to the front of F-25. The top edge should be flush and there should be an equal step on each side.

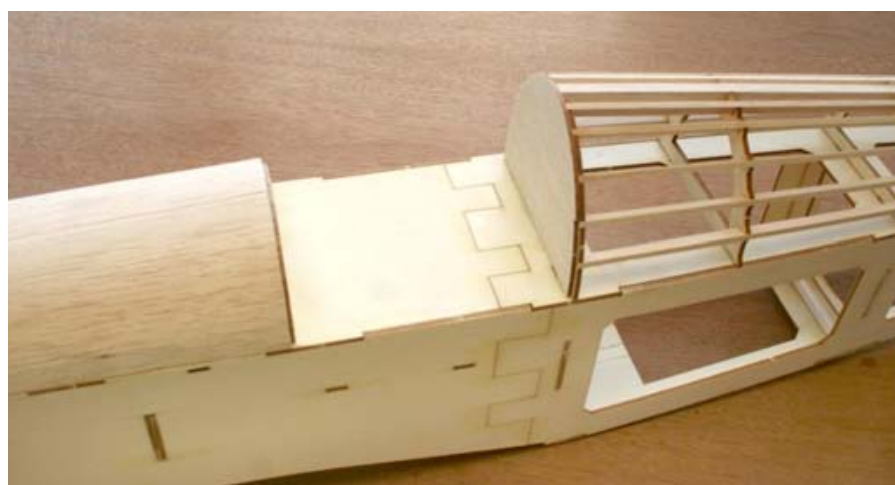

173...Place one F-30 into position on one side. It should be glued to the top of the fuselage and into the step in F-15A. Do not glue to F-24.



174...Moisten the outside of the sheet with an ammonia based window cleaner such as Windex. Roll the sheet around former F-24A. Trim it so that it ends at the centerline of the fuselage. Glue the sheet into place.



175...Glue the F-30 to the opposite side as you did the first.



176...Glue 8 F-31's together to make one tail block. Glue the other 8 F-31's together to make another tail block.



177...Glue the tail blocks into place on the back of the fuselage. Insert the fin to use as a guide for the correct spacing and to make sure that the slot is straight. Be careful that you do not glue the fin in place.

When the glue is dry, trim and sand the blocks to shape.



178...Bend the tailwheel wire to the shape shown on the plan.

179...Install the tail wheel wire into the tail wheel bracket and make the top bend as shown here and on the plan.

180...Drill a 1/16" hole in the leading edge of the rudder for the tail wheel wire. Cut on the dashed lines to remove the wood from the stabilizer slots on the fuselage sides. Temporarily mount the tailwheel bracket to the bottom of the fuselage. It should be positioned so that the 1/16" axle is just at the back of the fuselage as shown on the plan. Test fit the tail surfaces on the fuselage. Sand or trim if required to obtain the proper fit. The back edge of the stabilizer should be flush with the back end of the fuselage.

181...Glue two F-33's together. Glue two F-34's together to make one fairing side. Glue the other two F-34's together to make another fairing side.

182...Draw a line in the bottom fuselage sheet 1/4" forward of the back face of F-5.

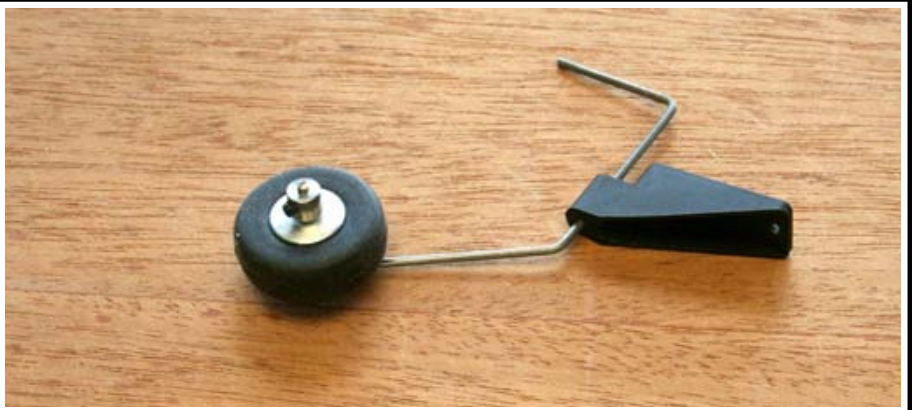

183...Trim the 3/32" lower sheet away back to the marked line.



184...Glue part of F-33 assembly into position on the bottom of F-5. Center it left and right.



185...Place an F-34 on the bottom skin, against the front of F-33 as shown. Mark a line on the bottom skin at the front of F-34 and the fuselage side. Now mark the other side of the bottom sheet.



186...Mark and cut away the bottom sheet 1/4" in from the fuselage side and the line that marks the front front of F-34. Do this on both sides.



187...Glue the F-34's into position on the fuselage side. They should be tight back against the F-33 and flush with the fuselage side and the edge of F-33. When the glue is dry, sand the F-34's and the end of F-33 flush with the fuselage side.



188...Attach the bottom wing. Sand F-33 and the F-34's flush with the bottom of the wing.



189...Remove the wing. Trim 1/32" away from the top of the F-34's from the back to the front. Then trim and sand a twist in the top of the F-34's from flat at the back end to angled flush with the angle of the bottom sheet at the front. You will see how this angle should progress and fit when you install the F-35's in the next step.

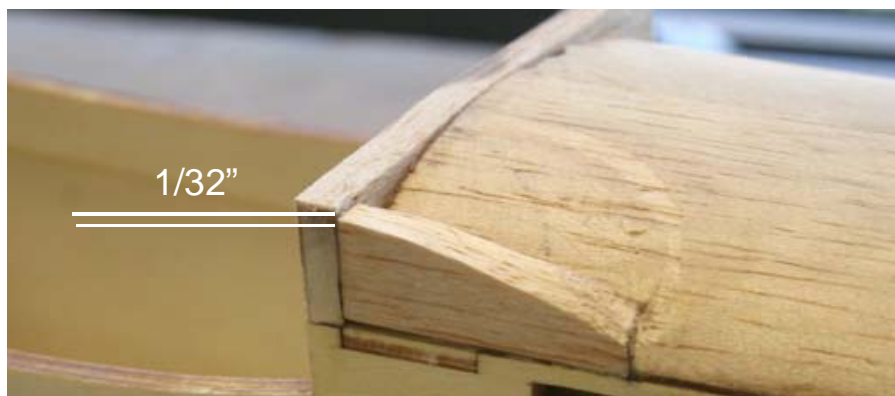

190...Test fit the F-35 pieces to the bottom of the fuselage as shown. The grain should run left to right. The back edge should be flush with and tight against F-33. The outboard edge should be flush with the outboard face of the F-34's. When you get the proper fit, glue the F-35's into position.

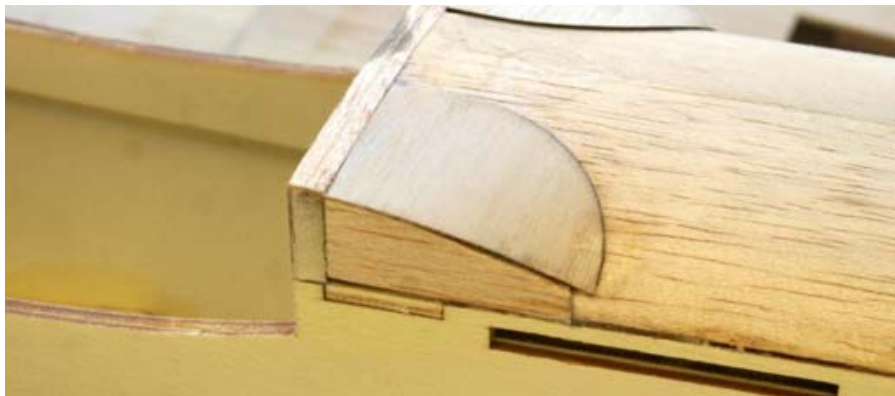

191...Fill in around the fairings with model balsa filler. When dry, sand the fairings flush and smooth.



192...Glue scrap balsa to the B-2 ribs to fill in the gap between the wing and the fuselage / fairings. Leave a space between the wing and fuselage of about 1/16" to allow for the covering.



193...Cut a small groove in the front of the rudder so the tailwheel wire sits flush with the front edge of the rudder. Glue the tailwheel wire into the rudder. Wrap a piece of 1" nylon tape around the wire and glue to the sides of the rudder.



Covering:

194...Sand the fuselage smooth all over. Round off all edges except for the wing saddle. Sand all parts smooth with 400 grit sandpaper. Feed strings from the aileron servo mounts to the center section. You will use these strings to pull the servo wires thru the wing after the model is covered. Cover the model with a plastic iron on covering material. Overlap all seams approximately 1/8".

Note: Do Not paint the ends of the cabane struts and landing gear that fit into the fuselage.

Note: After the model is covered you must check the tail surfaces and wings for warps or twists. If there are any they can be removed by twisting the parts straight and heating the covering.

Final Assembly

195...Cut the covering away from the stabilizer, fin and pushrod slots in the fuselage. Cut the covering away from the stabilizer in the area that makes contact with the fuselage.

Place the stabilizer into position on the fuselage. Make sure that it is straight and square and then glue it into position.

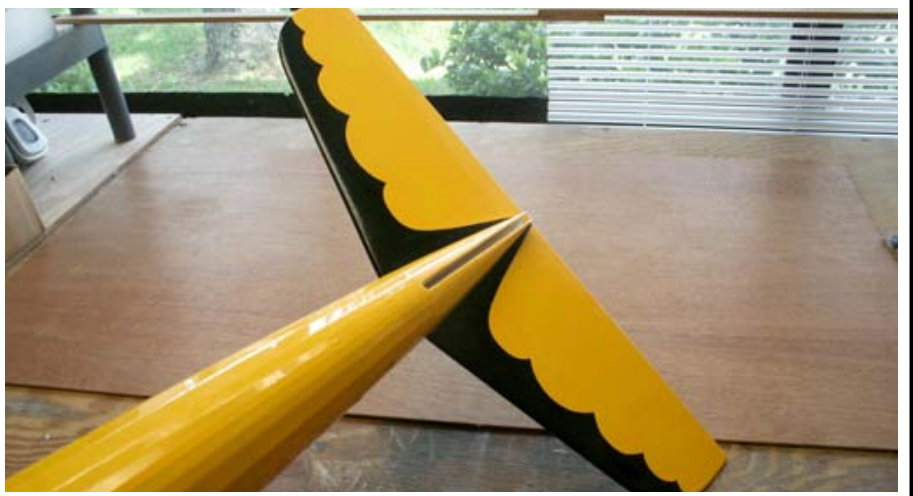

196...Attach the elevators with the hinges and glue in place.



197...Carefully cut the covering away from areas on the fin that will make contact with the fuselage. Place the fin into position and make sure that it is straight and square. Glue the fin into position.

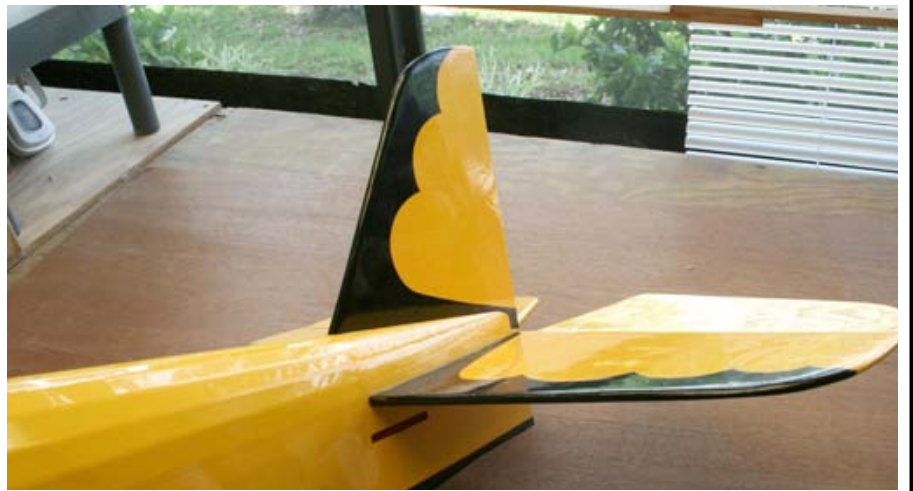

198...Attach the rudder with the hinges and glue in place.



199... Check the fit of the tail wheel bracket for the proper fit and the rudder for proper movement.



200...Screw the tailwheel bracket to the fuselage. Put a small drop of epoxy in the holes in the fuselage to lock the screws in place.



201...Screw the servos to the servo tray.



202...Insert the pushrod housings into the exit slots in the back of the fuselage. The front ends of the pushrod housings should pass thru the slot in former F-7. The back ends should stop 1-3/4" forward of the hinge lines. Glue the housings to the rear exits. Cut the front of the housings 1-1/2" from the servo arms. Do not glue the front ends to former F-7 at this time.



203...Attach the control horns to the elevator and rudder with **2-56 machine screws** and back plates. Align the horns with the pushrods. The holes in the horns should line up with the hinge lines.

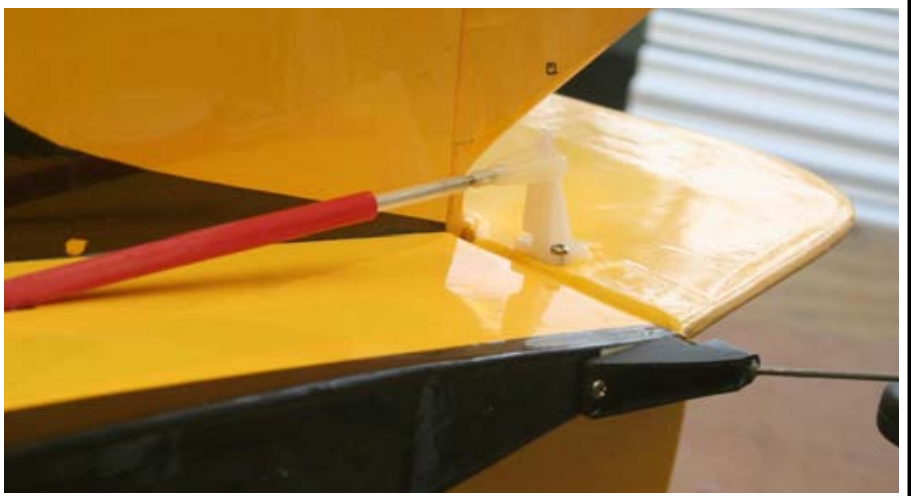

204...Assemble the back end of the pushrods. Slide the pushrods into the housings and connect the clevises to the horns.

205...Assemble the front ends of the pushrods and connect them to the servo arms. The control surfaces should be in neutral when the servos are centered.



Glue the pushrod housings to former F-7.

206...Seal the firewall with dope or epoxy. Drill the firewall for the throttle cable.



Attach the motor mount to the firewall. Glue the throttle cable housing into the firewall.

207...Assemble the fuel tank. Wrap with 1/4" foam rubber and slide onto the tank mount tray while pulling the fuel and vent line through the firewall.



Glue the throttle housing in the hole in the firewall.

208...Mount the motor to the model.

Make up the front end of the throttle cable and use a nylon clevis. Pass the throttle cable through the housing and attach the clevis to the throttle arm.

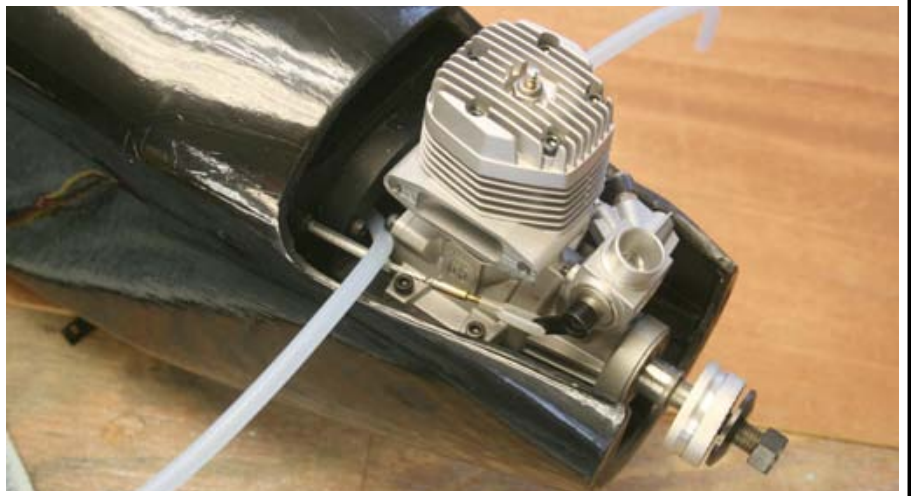

209...Secure the housing to F-5 with one of the F-36's. Secure the back end of housing to the fuselage side using the other F-36 and a scrap piece 3/8" sq. balsa as needed for alignment.

Attach the throttle cable to the servo with an EZ Connector.



210...Mount the muffler to the motor. Attach the fuel line to the motor. Attach the vent line to the muffler.



211...Secure the receiver and run the antenna in accordance with the radio's instructions. Wrap the battery pack in foam rubber and slide it in position under the fuel tank.



212...Seal the cockpit with dope or epoxy. Mount the radio switch in the cockpit as shown. We like using an external charging jack for the radio battery and mounted it in the cockpit next to the radio switch.



213...Cut the windshield to the shape using the pattern on the plan. Position on the fuselage in the correct location. Mark and remove the covering from the windshield location. Glue the windshield to the model.



214...Glue the 3/8" sq. x 1" bass servo mounts to the B-14 mount plates. Mount the aileron servos into position on the mounts. The servo arms should be angled about 30 degrees forward (we use 2 clicks on the splines on the servo arm) to the plate when the servo is in neutral and be centered left and right in the slot. **Be sure to make a left and a right hand assembly.**

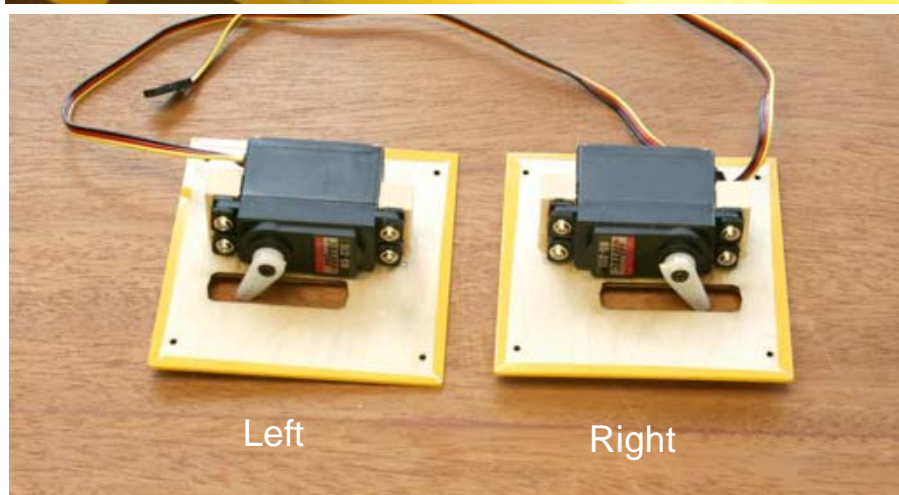

NOTE: Cut the bass servo mounts off flush with the servos so they do not contact the covering on the top of the wing.

215...Attach the ailerons to the wing with the hinges and glue in place.

Cut the covering away from the aileron servo openings.



216...Screw the servo mount plates to the wing. The servo arms should be forward and out-board as shown. Use the strings in the wing to feed the servo wires through the wing and out the center section.



217...Cut the 3/16" x 1/2" x 1/2" aileron horn wedge blocks to the angled shape as shown here and on the plans. Glue the tapered blocks to the bottom of the aileron control horns in the position shown.



218...Use a straight edge to locate the position of the horns on the ailerons. Mark the location of the horn on the aileron. See the plan for the proper position fore and aft.



219...Cut the covering away from the aileron in the position of the control horn. Glue the horn to the aileron. Screw the aileron control horns to the ailerons. Use #2 sheet metal screws. Use epoxy on the screws to secure them in place.



220...Assemble the aileron pushrods as shown on the plan. Install the pushrods making sure the ailerons are in neutral when the servos are in neutral.

NOTE: Be sure that the nylon clevis is completely threaded on the pushrod before assembling the pushrod.



221...Attach a "Y" harness to the aileron servos.



222...Place a washer on the axle screws. Insert the axle screws into the wheels. Install one nut on the axle and screw it down to the wheel. Back the nut off 1 turn to allow about 1/32" side play in the wheel. Now install a second nut to lock the first one in place. Now install a third nut as a spacer. Use a thread locking compound on these nuts.

Insert the axle into the landing gear and secure with a nut. Use a thread locking compound on this nut. Trim off the excess axle as required. See the plan for details.



223...Sand the top ends of the landing gear legs with 220 grit sandpaper to roughen them up. Attach the main landing gear to the fuselage with epoxy. The top end of the landing gear with the cut off corner is at the rear. Make sure that they are fully seated in the fuselage.



224...Sand the bottom ends of the cabane strut legs with 220 grit sandpaper to roughen them up. Attach the cabane struts to the fuselage with with epoxy. The diagonal part angles from the forward top to the bottom rear as shown. Make sure that they are fully seated in the fuselage.



225...Mark a centerline on the nylon "N" strut fittings as shown.



226...Place the fitting in a pair of side cutting pliers. Position the centerline on the cutting jaw.



Now...start squeezing the pliers **slowly**. As you start to squeeze, you will feel the jaws compress the fitting. Do this until you notice an increase in resistance. Stop at this point. **DO NOT CUT THE FITTINGS.**

227...Fold the fitting in half on the indented line. Place in a standard pair of pliers and squeeze together tightly.



228...When you remove the fitting from the pliers, it will have formed the angle shape shown.

Make all eight "N" strut fittings like this.



229...Locate the holes in the "N" strut blocks in the wings and poke a hole in the covering at the hole locations. Using 1/2" sheet metal screws, attach the "N" strut fittings to the wings. Use a small drop of epoxy to secure the screws in the wing.

NOTE: The upright leg of the fitting faces outboard as shown.

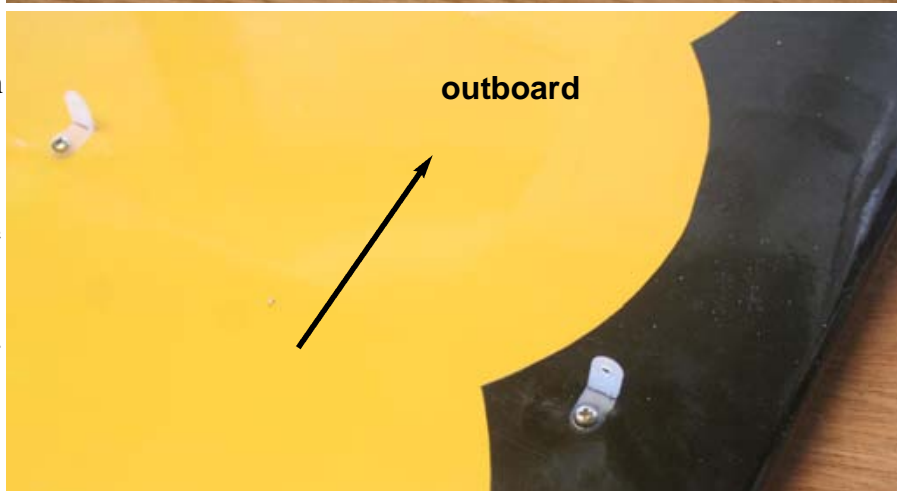

230...Attach the top wing to the model using the 6-32 x 1/2" screws. Gently squeeze the threaded section of the screws in a pair of pliers to slightly deform the threads. This will produce a tighter fit in the blind nuts and help prevent the screws from coming loose.

NOTE: Always check the cabane screws for tightness before every flight. DO NOT fly the model if the screws are loose. DO NOT fly the model if you have not checked the screws for tightness immediately before flying.



231...Install the wings on the model. Set the model on your workbench and level it left to right. Put an incidence meter on the bottom wing at the fuselage sides and block up the tail until the meter reads zero. Now place the incidence meter at each wing tip of the bottom wing. The meter should read zero at the tips as it did at the fuselage sides. If the wings have any twist in them, adjust them by shrinking the covering material until the tips match the center at the fuselage sides.

Put an incidence meter on the T-1 / T-3 ribs at the outboard ends of the center section of the top wing. Block up the tail until the meter reads zero. Now place the incidence meter at each wing tip of the top wing. The meter should read zero at the tips as it did at the center section. If the wing has any twist in it, adjust it by shrinking the covering material until the tips match the center section.

232...DO NOT BUILD THE “N” STRUTS ON THE PLAN.

BUILD THE “N” STRUTS IN PLACE ON THE MODEL.

Measure and cut the front and rear “N” strut pieces and install on the model.



233...Now, mark the screw locations in the ends of the struts using the fittings as a guide.

Mark the struts so you know which is left and right. Now, mark the screw locations in the ends of the struts using the fittings as a guide. Mark the struts so you know which is left and right.

234...Carefully drill out the holes in the ends of the struts with a 5/32” drill bit. Press the 4-40 blind nuts into the holes in the struts. The should be positioned on the inboard face of the struts. Fully seat the blind nuts in the struts and secure them with a small drop of thin C/A glue.

235...Cut, fit and glue the diagonal piece of the “N” struts into position. **The “N” struts should not be tight against the wing or put any pressure on the wings that might cause them to twist.**

Remove the “N” struts from the model. Apply additional glue to the joints to securely glue the struts together. Do not glue the struts to the wing.



236...Sand the struts, between the ends, to the cross section shown on the plans. The ends will end up being a little square because of the blind nuts. Finish the struts to match the color of the model. Mark the struts so you know which is left and right. Also make a mark so you know which end is the top.



237...Attach the “N” struts to the model with the 4-40 x 3/8” screws. They go on the inside of the fittings.



238...Check the servos for proper operation and direction. Adjust the control throws to the values shown on the plan. Attach the propeller. Attach the wings onto the fuselage.

239...Check the balance of the model. It should balance at the position shown on the plan. Move the battery forward or aft to achieve the proper balance. Note: If moving the battery will not achieve the proper balance, you will have to add weight to the nose or tail. Glue or bolt any weight securely to the model.

240...Your model is now ready to fly. Fully charge the transmitter and airborne battery before attempting to fly the model. Always range check and do a thorough pre-flight of the model before every flight. Always follow established safety guidelines while operating the motor, radio and flying your model.

LIPO BATTERY SAFETY ALERT

Lithium Battery Fires

Lithium batteries are becoming very popular for powering the control and power systems in our models. This is true because of their very high energy density (amp-hrs/wt. ratio) compared to NiCd's or other batteries. With high energy comes increased risk in their use. The principal risk is FIRE which can result from improper charging, crash damage, or shorting the batteries. All vendors of these batteries warn their customers of this danger and recommend extreme caution in their use. In spite of this, many fires have occurred as a result of the use of Lithium Polymer batteries resulting in loss of models, automobiles, and other property. Homes and garages and workshops have also burned. A lithium battery fire is very hot (several thousand degrees) and is an excellent initiator for ancillary (resulting) fires. Fire occurs due to contact between Lithium and oxygen in the air. It does not need any other source of ignition, or fuel to start, and burns almost explosively. These batteries must be used in a manner that precludes ancillary fire. The following is recommended:

1. Store, and charge, in a fireproof container; never in your model.
2. Charge in a protected area devoid of combustibles. Always stand watch over the charging process. Never leave the charging process unattended
3. In the event of damage from crashes, etc, carefully remove to a safe place for at least a half hour to observe. Physically damaged cells could erupt into flame and after sufficient time to ensure safety, should be discarded in accordance with the instructions which came with the batteries. Never attempt to charge a cell with physical damage, regardless of how slight.
4. Always use chargers designed for the specific purpose, preferably having a fixed setting for your particular pack. Many fires occur in using selectable/adjustable chargers improperly set. Never attempt to charge Lithium cells with a charger which is not specifically designed for charging Lithium cells. Never use chargers designed for Nickel Cadmium batteries.
5. Only use charging systems that monitor and control the charge state of each cell in the pack. Unbalanced cells can lead to disaster if it permits overcharge of a single cell in the pack. If the batteries show any sign of swelling, discontinue charging and remove them to a safe place outside as they could erupt into flames.
6. Most important: NEVER PLUG IN A BATTERY AND LEAVE IT TO CHARGE UNATTENDED OVERNIGHT. Serious fires have resulted from this practice.
7. Do not attempt to make your own battery packs from individual cells.

These batteries CANNOT be handled and charged casually such as has been the practice for years with other types of batteries. The consequence of this practice can be very serious resulting in major property damage and/or personal harm.

NOTES ABOUT ARMING SWITCHES:

***YOU MUST USE AN ARMING SWITCH IF FLYING ANY MODEL WITH ELECTRIC POWER. THIS IS AN IMPORTANT SAFETY ITEM.**

***THE PLUG SHOULD ONLY BE INSERTED IN THE ARMING SWITCH IMMEDIATELY PRIOR TO FLIGHT.**

***ALWAYS REMOVE THE PLUG FROM THE ARMING SWITCH IMMEDIATELY AFTER EVERY FLIGHT.**

***THE PLUG SHOULD NEVER BE INSERTED IN THE ARMING SWITCH WHILE CHANGING OR INSTALLING THE BATTERY IN THE MODEL.**

***BE ABSOLUTELY SURE THAT THERE ARE NO OBJECTS, CLOTHING, BODY PARTS, ETC. ANYWHERE NEAR THE PROPELLER AND THAT THE MODEL IS SECURELY RESTRAINED BEFORE INSTALLING THE PLUG IN THE ARMING SWITCH.**