

CLASSIC UGLY STICK 10-15cc



“ Graphics and specifications may change without notice “.

Code : SEA255



Specifications:

Wingspan-----70.9 in (180 cm).

Wing area-----1033.2 sq.in (66.7 sq.dm).

Weight-----7.7 lbs (3.5 kg).

Length-----57.8 in (146.8 cm).

Engine-----10cc - 15cc gasoline

-----.60 -.91 glow engine

-----1200-1500 Watt Brushless Motor

Radio-----4 channels with 5 servos.

Electric conversion: Optional.

INTRODUCTION.

Thank you for choosing the **CLASSIC UGLY STICK ARTF** by **SEAGULL MODELS COMPANY LTD.**, The **CLASSIC UGLY STICK** was designed with the intermediate/advanced sport flyer in mind. It is a sport airplane which is easy to fly and quick to assemble. The airframe is conventionally built using balsa, plywood to make it stronger than the average ARTF, yet the design allows the aeroplane to be kept light. You will find that most of the work has been done for you already. The motor mount has been fitted and the hinges are pre-installed. Flying the **CLASSIC UGLY STICK** is simply a joy.

This instruction manual is designed to help you build a great flying aeroplane. Please read this manual thoroughly before starting assembly of your **CLASSIC UGLY STICK** . Use the parts listing below to indentify all parts.

WARNING.

Please be aware that this aeroplane is not a toy and if assembled or used incorrectly it is capable of causing injury to people or property. WHEN YOU FLY THIS AEROPLANE YOU ASSUME ALL RISK & REponsibility.

If you are inexperienced with basic R/C flight we strongly recommend you contact your R/C supplier and join your local R/C model Flying Club. R/C Model Flying Clubs offer a variety of training procedures designed to help the new pilot on his way to successful R/C flight. They will also be able to advise on any insurance and safety regulations that may apply.

KIT CONTENTS

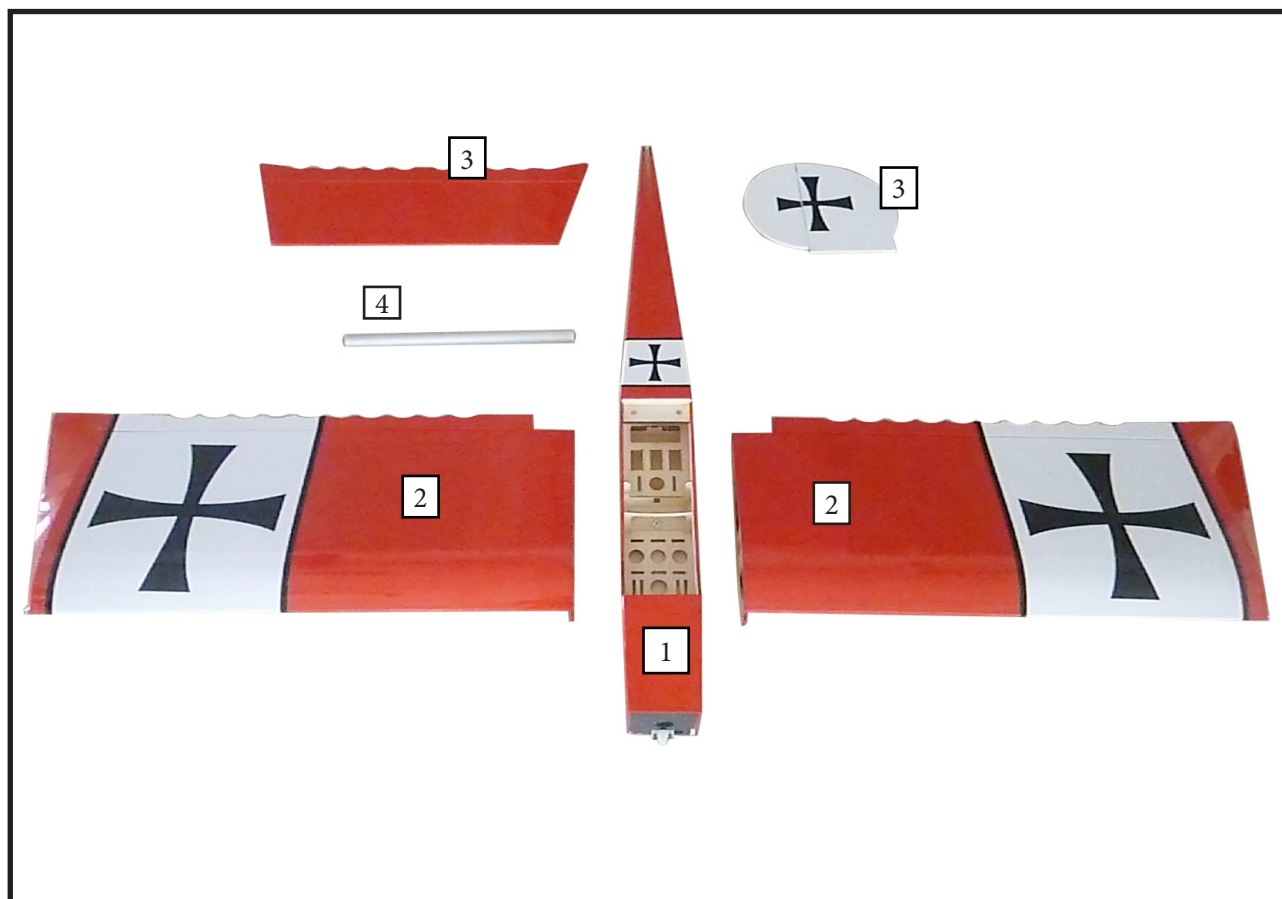

KIT CONTENTS.

SEA255 CLASSIC UGLY STICK

- SEA25501 Fuselage
- SEA25502 Wing set
- SEA25503 Tail set
- SEA25504 Aluminum tube

ADDITIONAL ITEMS REQUIRED.

- 10cc-15cc gasoline engine.
- .60 - .91 glow engine.
- 1200-1500 Watt Brushless Motor.
- Computer radio with 5 servos.
- Glow plug to suit engine.
- Propeller to suit engine.
- Protective foam rubber for radio system.

TOOLS & SUPPLIES NEEDED.

- Thin cyanoacrylate glue.
- 30 minute epoxy.
- 5 minute epoxy.
- Hand or electric drill.
- Assorted drill bits.
- Modelling knife.
- Straight edge ruler.
- 2mm ball driver.
- Phillips head screwdriver.
- 220 grit sandpaper.
- 90° square or builder's triangle.
- Wire cutters.
- Masking tape & T-pins.
- Thread-lock.
- Paper towels.

HINGING THE AILERON.

Note : The control surfaces, including the ailerons, elevators, and rudder, are prehinged with hinges installed, but the hinges are not glued in place. It is imperative that you properly adhere the hinges in place per the steps that follow using a high-quality thin C/A glue.

1) Carefully remove the aileron from one of the wing panels. Note the position of the hinges.

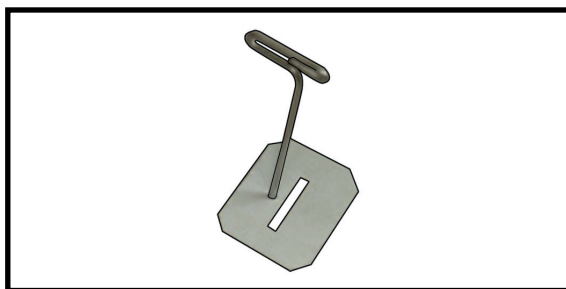

2) Remove each hinge from the wing panel and aileron and place a T-pin in the center of each hinge. Slide each hinge into the wing panel until the T-pin is snug against the wing panel. This will help ensure an equal amount of hinge is on either side of the hinge line when the aileron is mounted to the aileron.

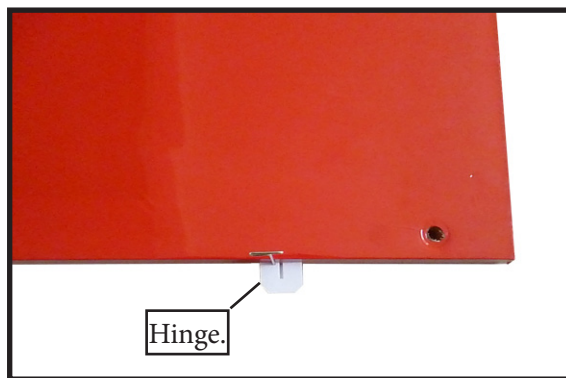

3) Slide the wing panel on the aileron until there is only a slight gap. The hinge is now centered on the wing panel and aileron. Remove the T-pins and snug the aileron against the wing panel. A gap of 1/64" or less should be maintained between the wing panel and aileron.

4) Deflect the aileron and completely saturate each hinge with thin C/A glue. The ailerons front surface should lightly contact the wing during this procedure. Ideally, when the hinges are glued in place, a 1/64" gap or less will be maintained throughout the length of the aileron to the wing panel hinge line.

NOTE : The hinge is constructed of a special material that allows the C/A to wick or penetrate and distribute throughout the hinge, securely bonding it to the wood structure of the wing panel and aileron.

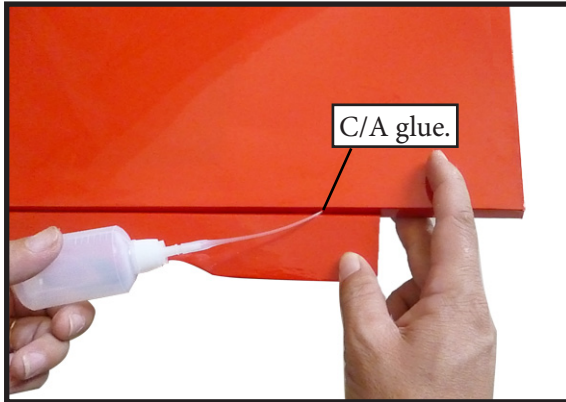

5) Turn the wing panel over and deflect the aileron in the opposite direction from the opposite side. Apply thin C/A glue to each hinge, making sure that the C/A penetrates into both the aileron and wing panel.

6) Using C/A remover/debonder and a paper towel, remove any excess C/A glue that may have accumulated on the wing or in the aileron hinge area.

7) Repeat this process with the other wing panel, securely hinging the aileron in place.

8) After both ailerons are securely hinged, firmly grasp the wing panel and aileron to make sure the hinges are securely glued and cannot be pulled out. Do this by carefully applying medium pressure, trying to separate the aileron from the wing panel. Use caution not to crush the wing structure.

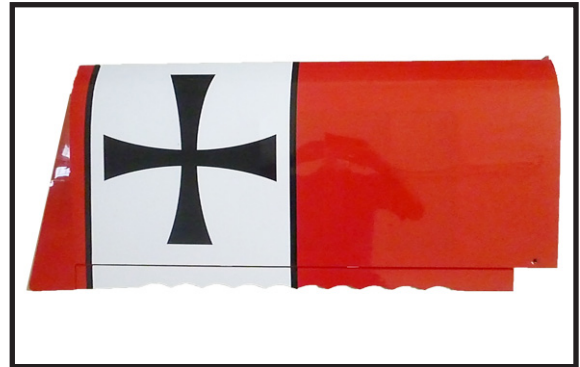

Note : Work the aileron up and down several times to “work in” the hinges and check for proper movement.

INSTALL THE AILERONS CONTROL HORN.

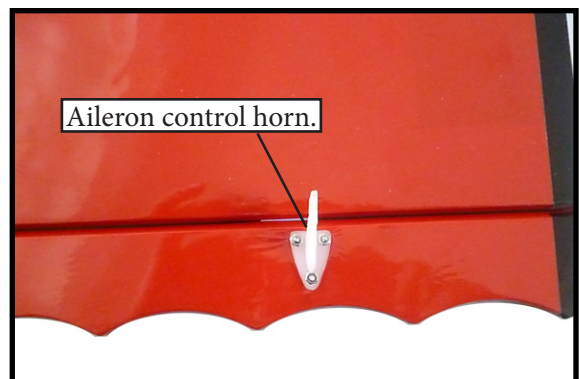

WING ASSEMBLY.

Please see below pictures.

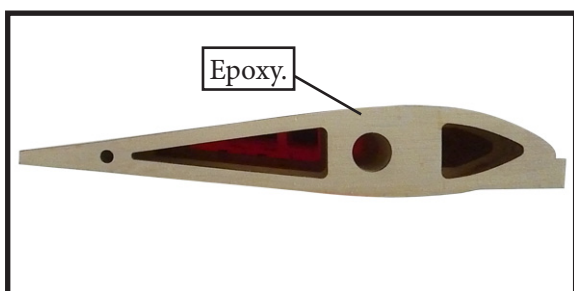

Attach the aluminum tube into wing.

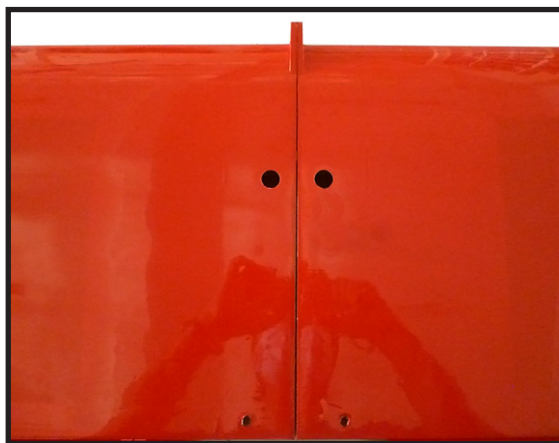
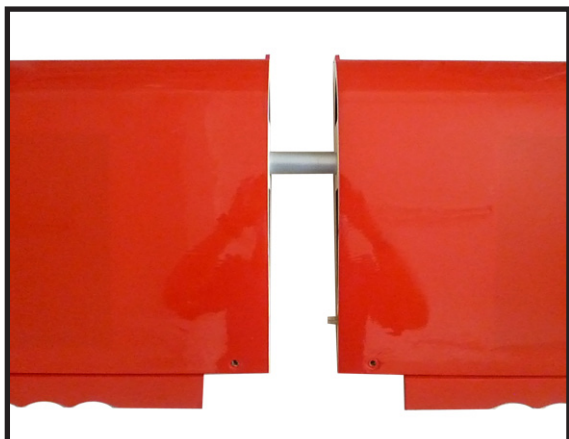

INSTALLING THE AILERON SERVOS.

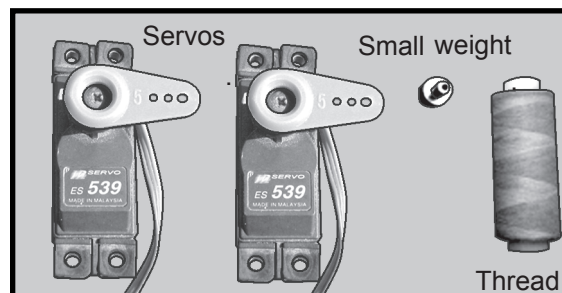
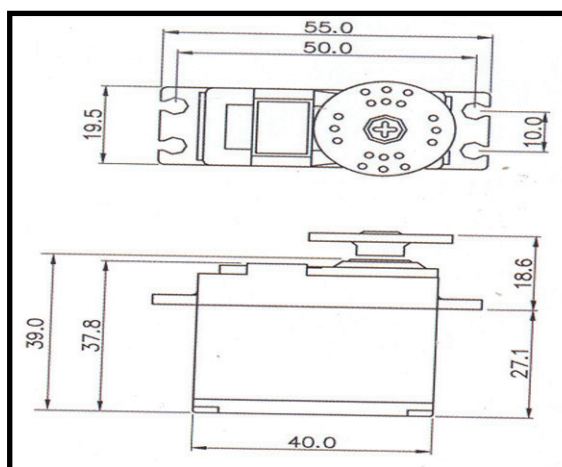

1) Install the rubber grommets and brass collets onto the aileron servo. Test fit the servo into the aileron servo mount.

! *Because the size of servos differ, you may need to adjust the size of the precut opening in the mount. The notch in the sides of the mount allow the servo lead to pass through.*

2) Using a small weight (Weighted fuel pick-up works well) and thread, feed the string through the wing as indicated.

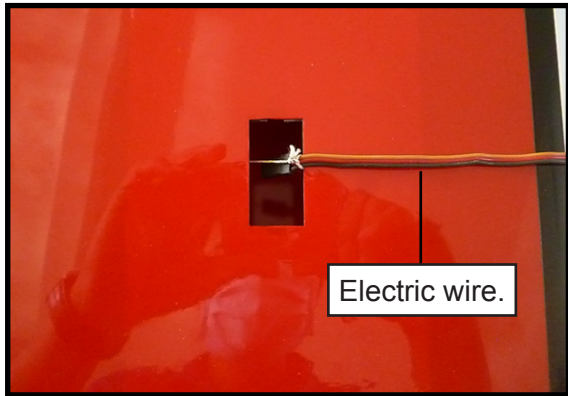

3) Attach servo lead to the aileron servo. Attach the string to the servo lead and carefully thread it through the wing. Once you have thread the lead through the wing, remove the string so it can use for the other servo lead.

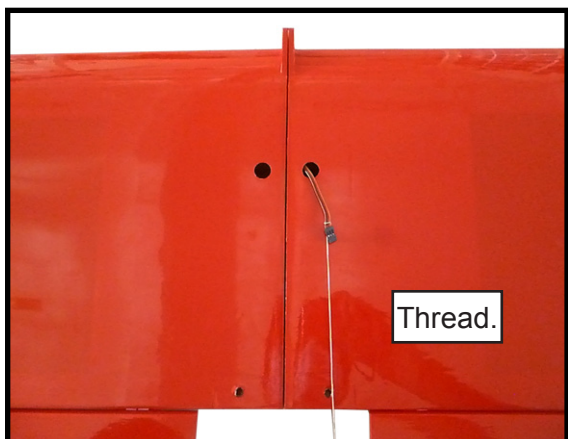
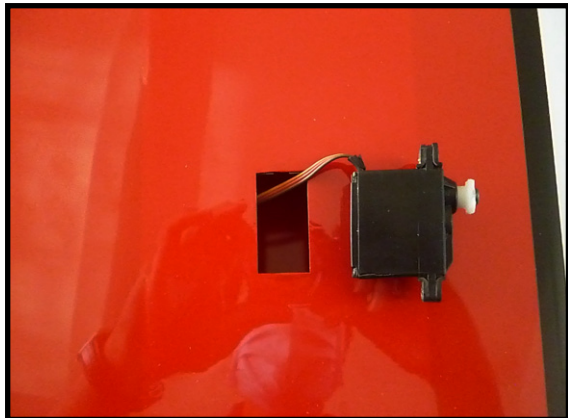

4) Tape the servo lead to the wing to prevent it from falling back into the wing.

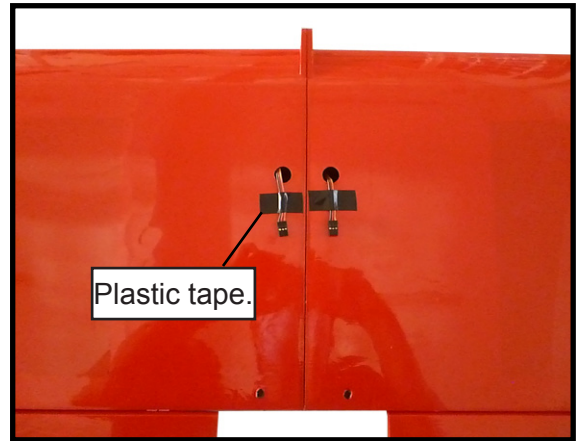

5) Reinstall the servo into the servo mount and secure the servo in place using the wood screws provided with your radio system.



Repeat the procedure for the other wing half.

**AILERON PUSHROD HORN
INSTALLATION.**

Please see below pictures.

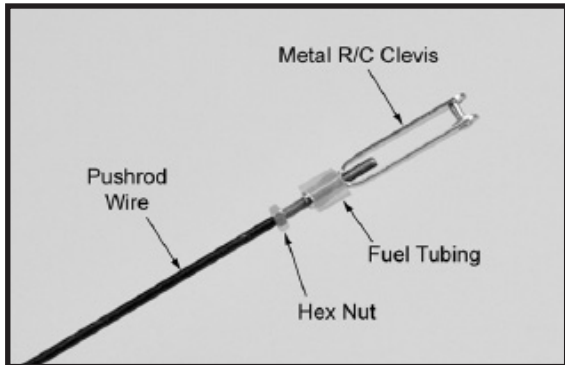

Use a felt tip pen to mark the wire where it crosses the hole. Use a pair of pliers to put a sharp 90-degree bend in the wire at the mark.

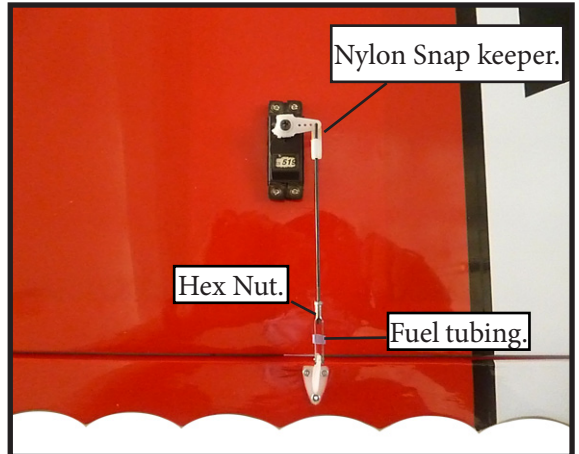
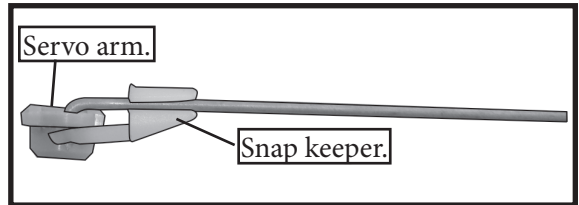
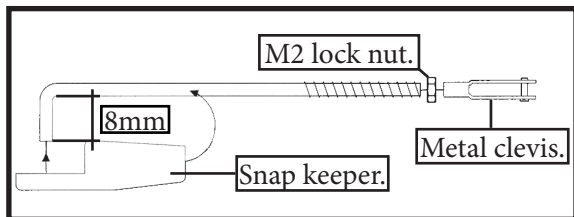
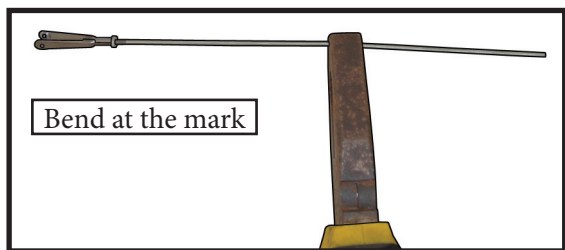
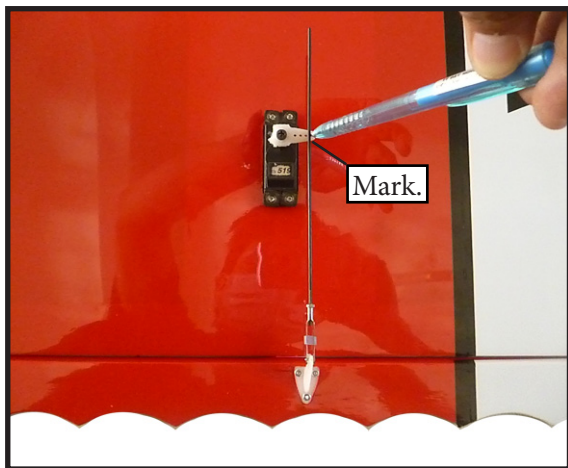

ATTACHMENT WING- FUSELAGE.

Please see below pictures.

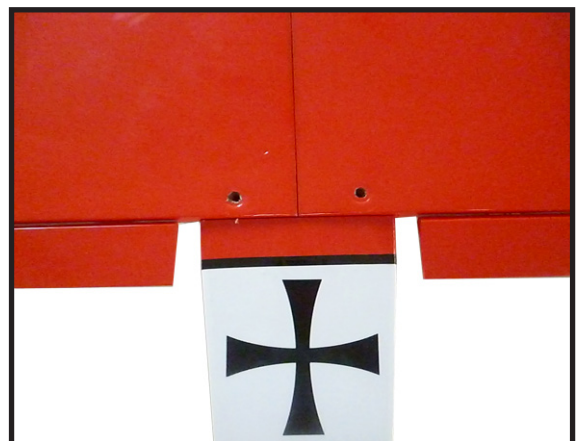
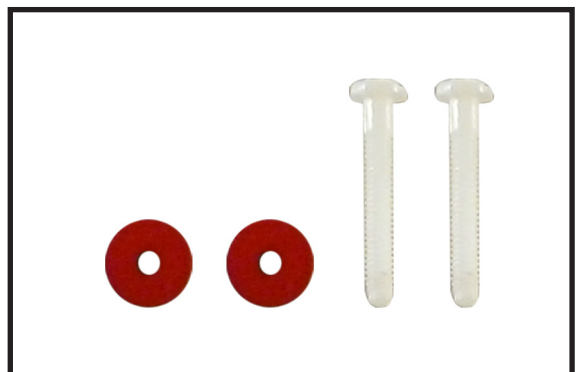

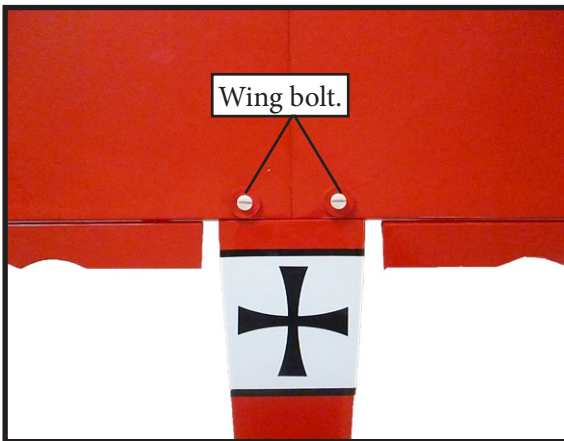

INSTALLING THE FUSELAGE SERVOS.

! Because the size of servos differ, you may need to adjust the size of the precut opening in the mount. The notch in the sides of the mount allow the servo lead to pass through.

- 1) Install the rubber grommets and brass collets onto all servos. Test fit the servos into the servo mount.
- 2) Secure the servos with the screws provided with your radio system.

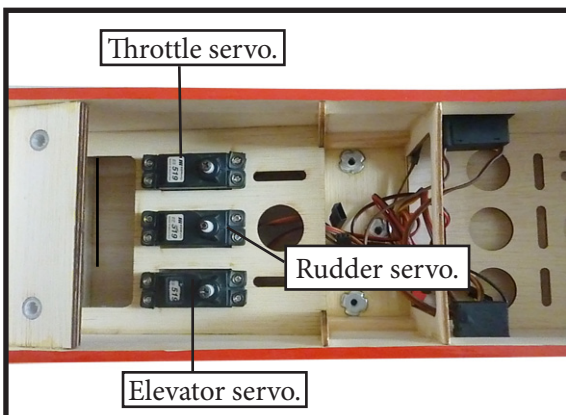

THROTTLE SERVO ARM INSTALLATION.

Install adjustable servo connector in the servo arm as same as picture below:

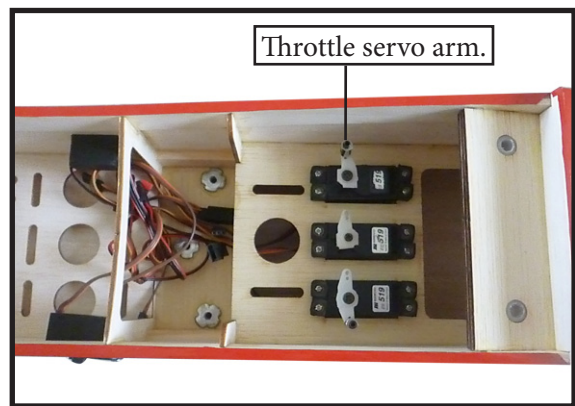
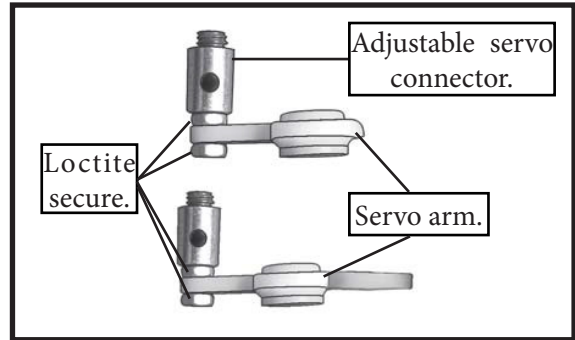

INSTALLING THE RECEIVER SWITCH.

Install the switch into the precut hole in the side, in the fuselage.

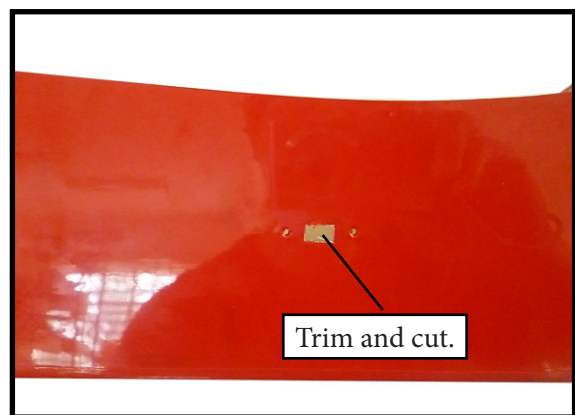
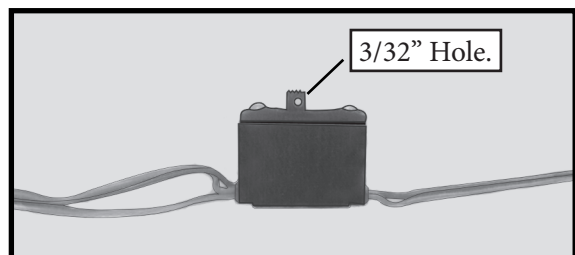

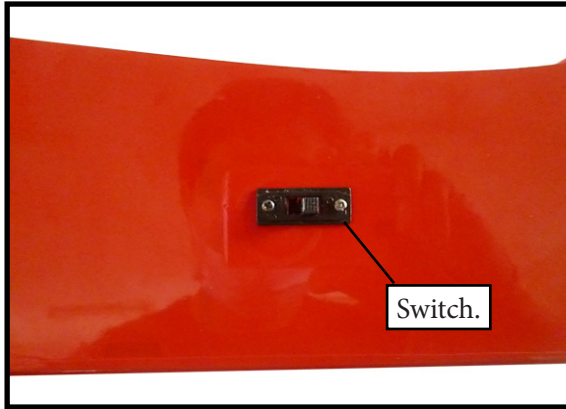

INSTALLING THE ENGINE SWITCH.

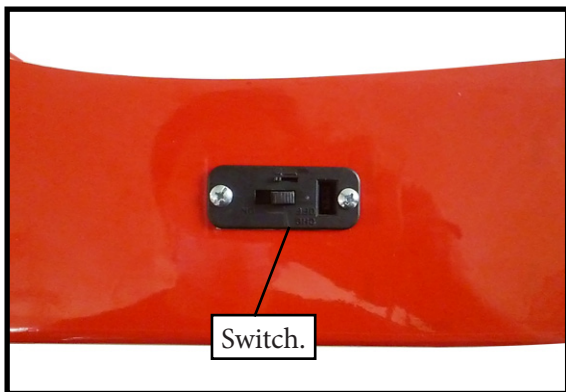
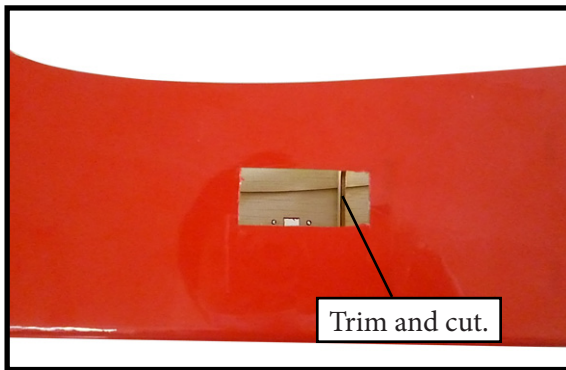

INSTALLING THE STOPPER ASSEMBLY.

- 1) Using a modeling knife, carefully cut off the rear portion of one of the 3 nylon tubes leaving 1/2" protruding from the rear of the stopper. This will be the fuel pick up tube.
- 2) Using a modeling knife, cut one length of silicon fuel line. Connect one end of the line to the weighted fuel pick up and the other end to the nylon pick up tube.

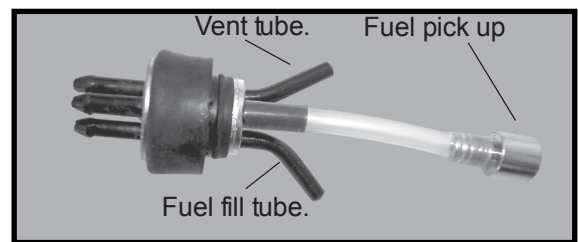
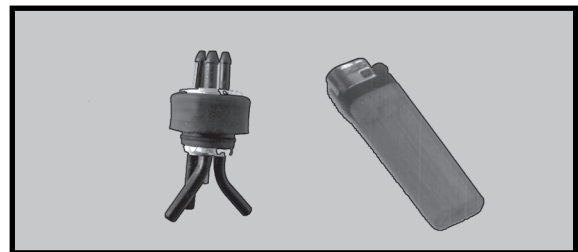
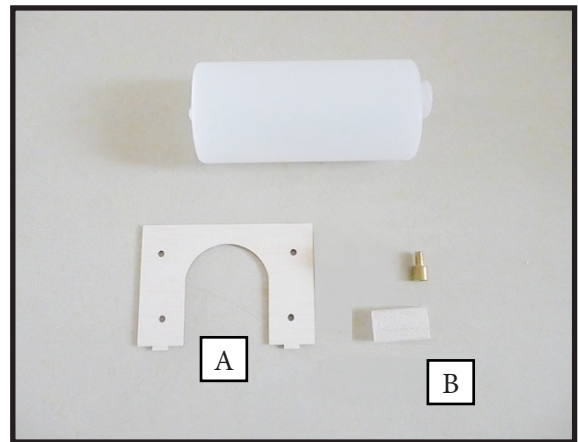
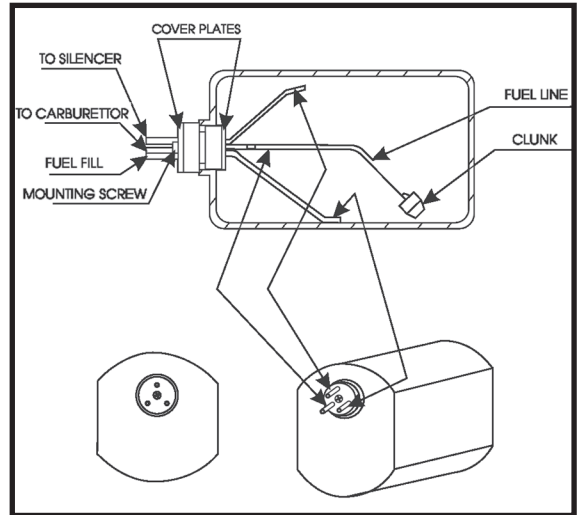

- 3) Carefully bend the second nylon tube up at a 45° angle. This tube is the vent tube.
- 4) Test fit the stopper assembly into the tank. It may be necessary to remove some of the flashing around the tank opening using a modeling knife. If flashing is present, make sure none falls into the tank.

5) With the stopper assembly in place, the weighted pick-up should rest away from the rear of the tank and move freely inside the tank. The top of the vent tube should rest just below the top of the tank. It should not touch the top of the tank.

6) When satisfied with the alignment of the stopper assembly tighten the 3 x 20mm machine screw until the rubber stopper expands and seals the tank opening. Do not over-tighten the assembly as this could cause the tank to split.

FUEL TANK INSTALLATION.

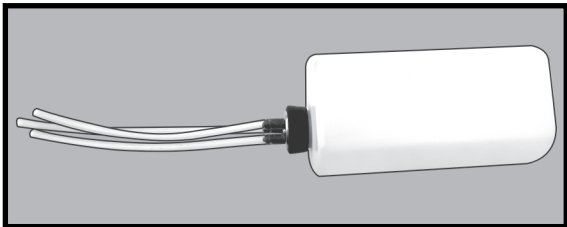

! *You should mark which tube is the vent and which is the fuel pickup when you attach fuel tubing to the tubes in the stopper. Once the tank is installed inside the fuselage, it may be difficult to determine which is which.*

7) Slide the fuel tank into the fuselage. Guide the lines from the tank through the hole in the firewall.

8) Use plywood template to hold in place the fuel tank with C/A glue to secure the fuel tank inside the fuselage.

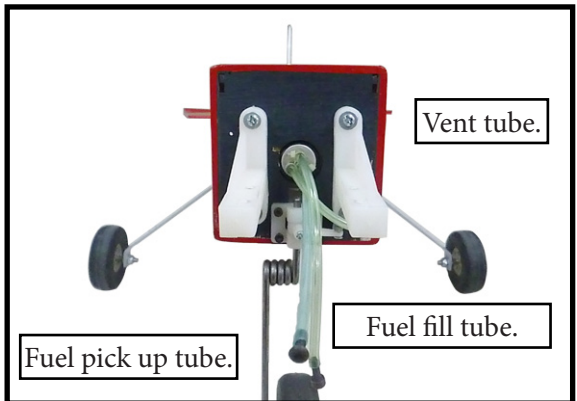
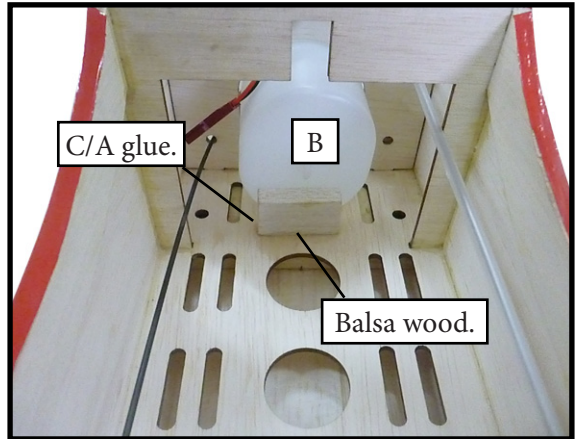
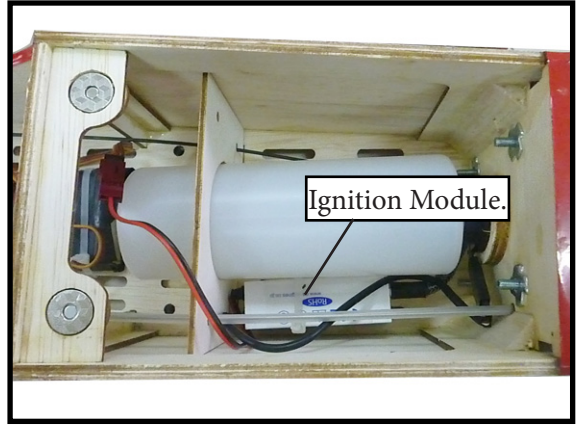
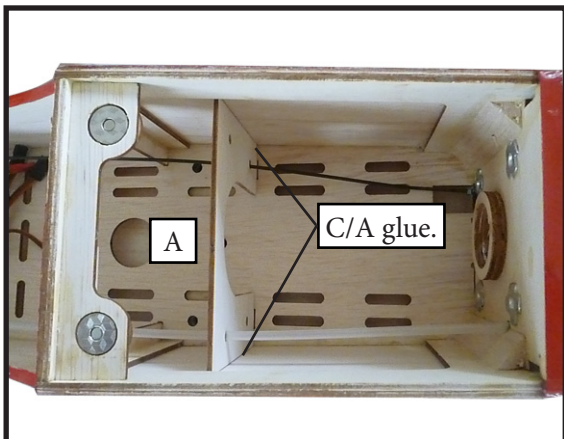

9) Connect the lines from the tank to the engine and muffler. The vent line will connect to the muffler and the line from the clunk to the carburetor.

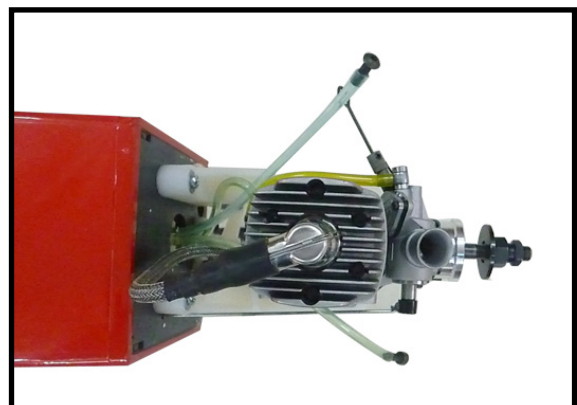

⚠ Blow through one of the lines to ensure the fuel lines have not become kinked inside the fuel tank compartment. Air should flow through easily.

ENGINE MOUNT INSTALLATION.

1) Locate the items necessary to install the engine mount included with your model.

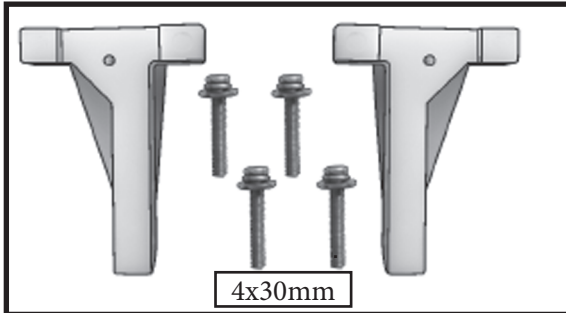

2) Use four 4x30mm head bolts and four 4mm washers to attach the engine mount rails to the firewall. Tighten the screws. Make sure to use threadlock on the screws to help prevent them from vibrating loose.

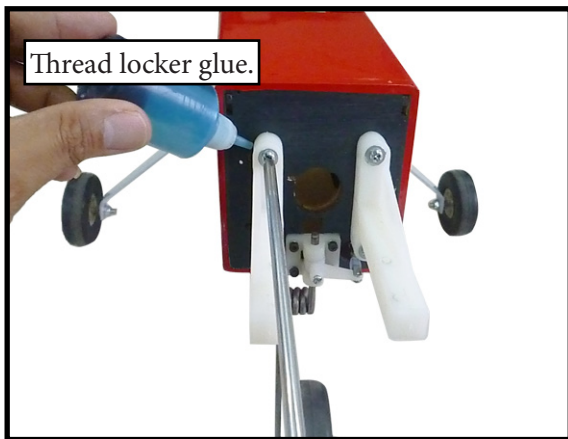

MOUNTING THE ENGINE.

1) Position the engine with the drive washer (140mm) forward of the firewall as shown.

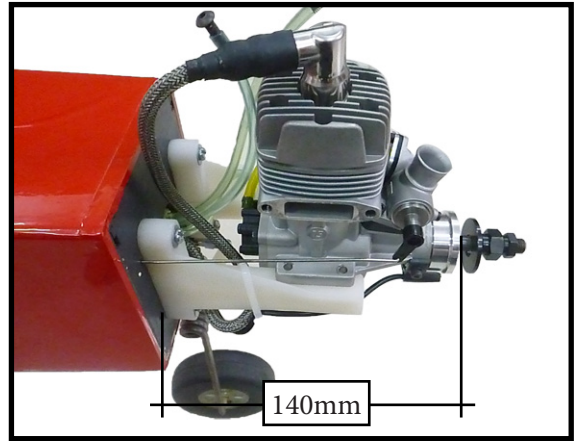

2) Use a pin drill and 4mm drill bit to drill a small indentation in the mount for the engine mounting screw.

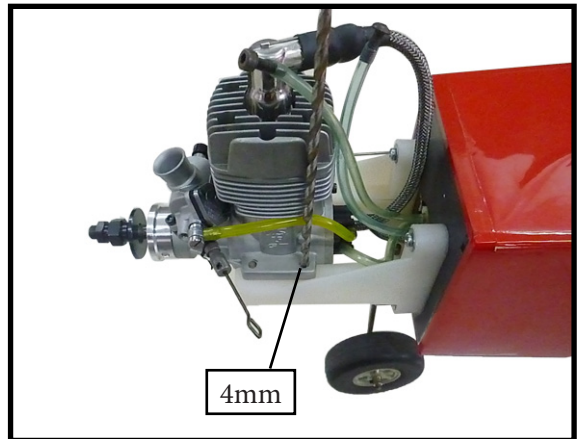

3) Use a drill to drill the four holes in the engine mount rails.

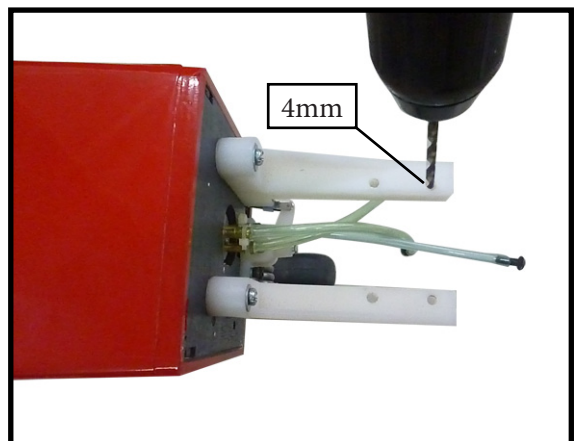

4) On the fire wall has the location for the throttle pushrod tube (pre-drill).

5) Slide the pushrod tube in the firewall and guide it through the fuel tank mount. Use medium C/A to glue the tube to the firewall and the fuel tank mount.

6) Connect the Z-bend in the 450mm throttle pushrod to the outer hole of the carburetor arm.

7) Slide the throttle pushrod wire into the tube. Position the engine between the mounts. Use four M4x30mm machine screws to secure the engine to the mount as shown.

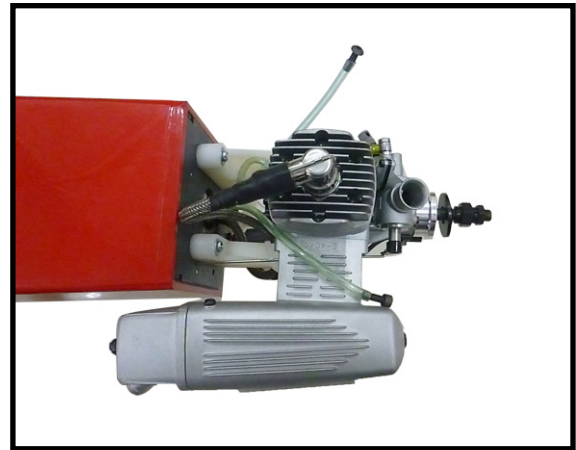
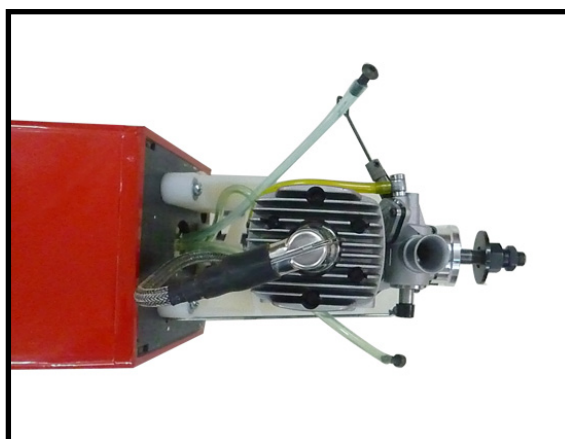
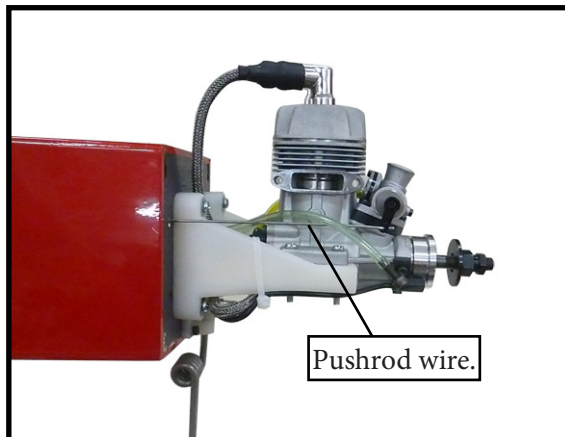
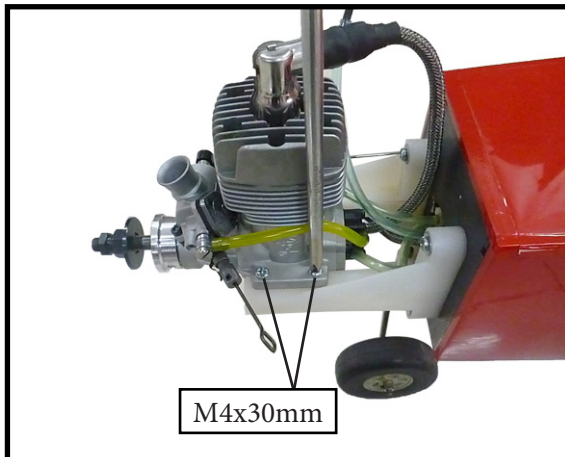

8) Reinstall the servo horn by sliding the connector over the pushrod wire. Center the throttle stick and trim and install the servo horn perpendicular to the servo center line.

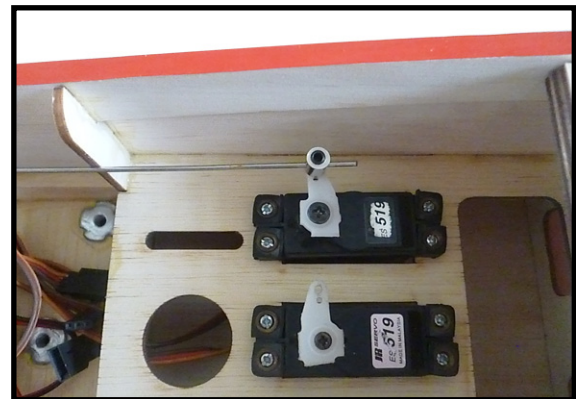

9) Move the throttle stick to the closed position and move the carburetor to closed. Use a 2.5mm hex wrench to tighten the screw that secures the throttle pushrod wire. Make sure to use threadlock on the screw so it does not vibrate loose.

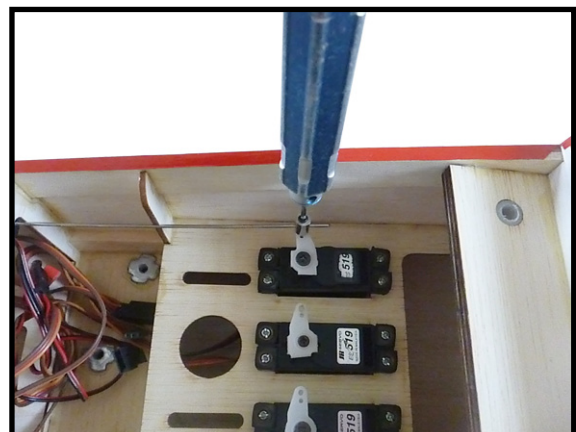

ELECTRIC POWER CONVERSION.

1) Locate the items necessary to install the electric power conversion included with your model.

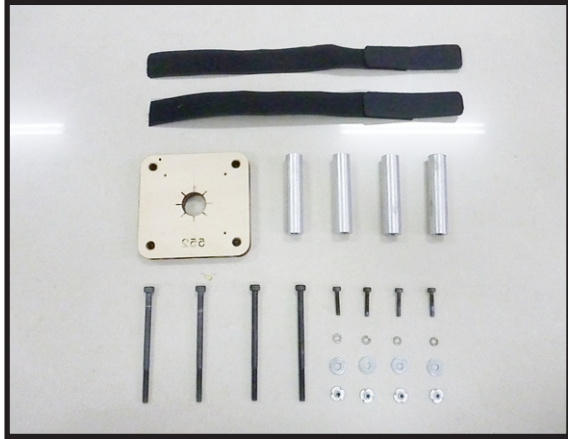

- Motor : .60
- Propeller: 14x 8 ~ 16x10
- ESC: 60A
- 5S-7S Lipo

2) Attach the electric motor box to the firewall suitable with the cross lines drawn on the electric motor box and firewall. Using epoxy and balsa stick to secure the motor box to the firewall. Please see below pictures.

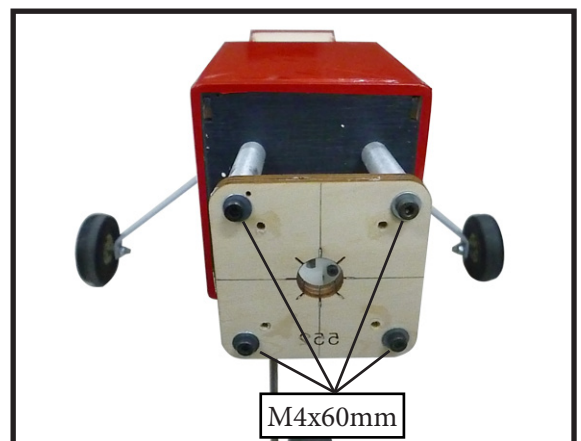
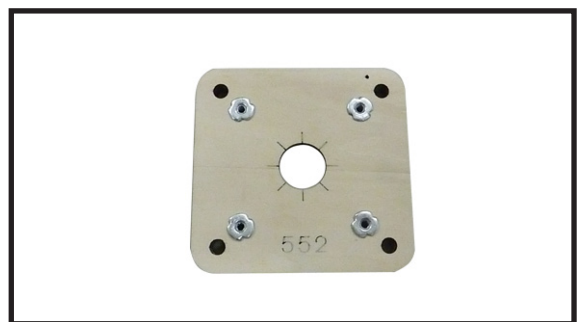
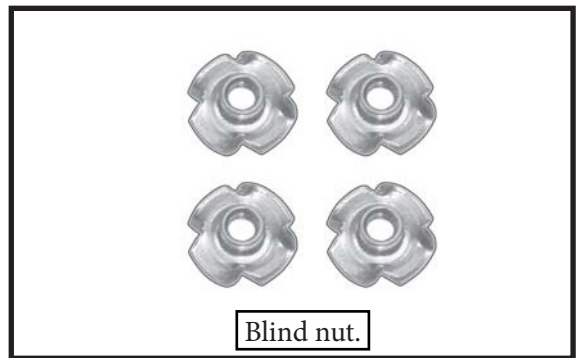
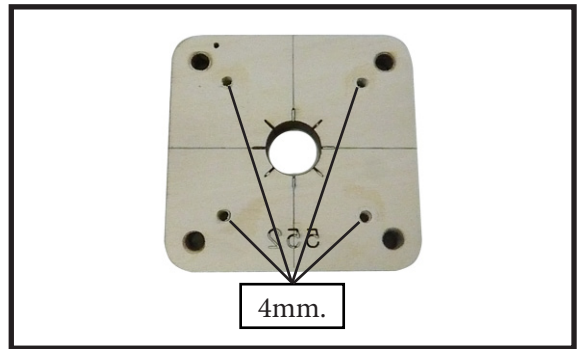
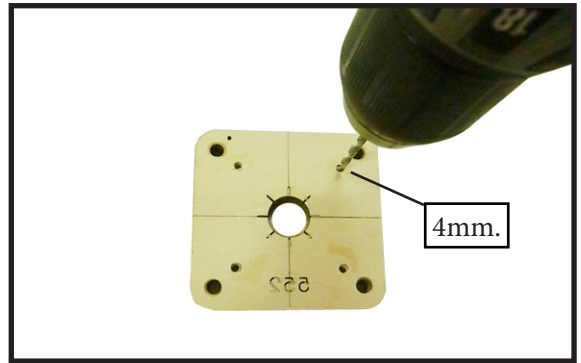
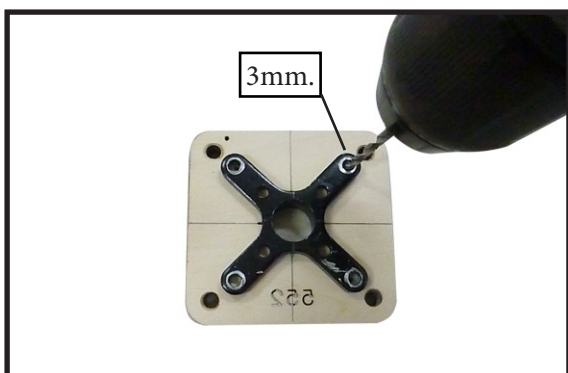
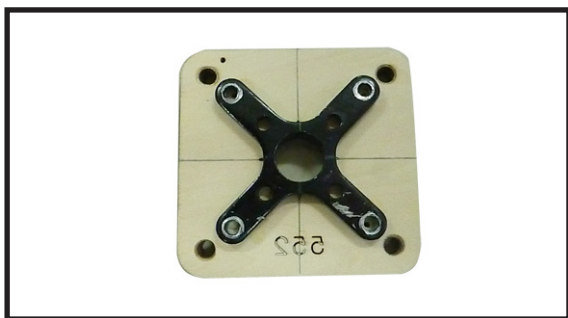

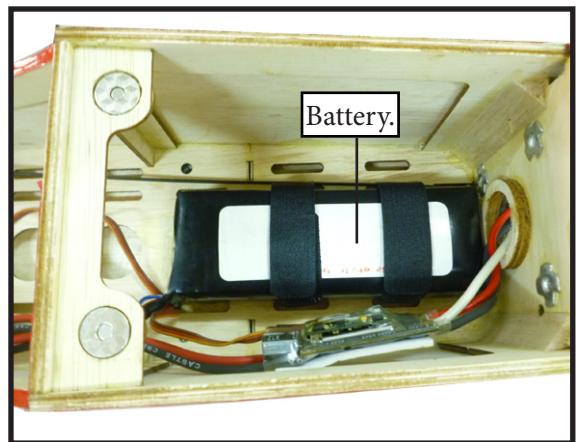
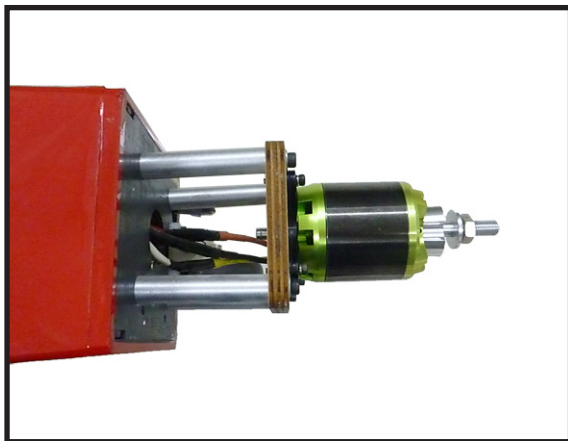
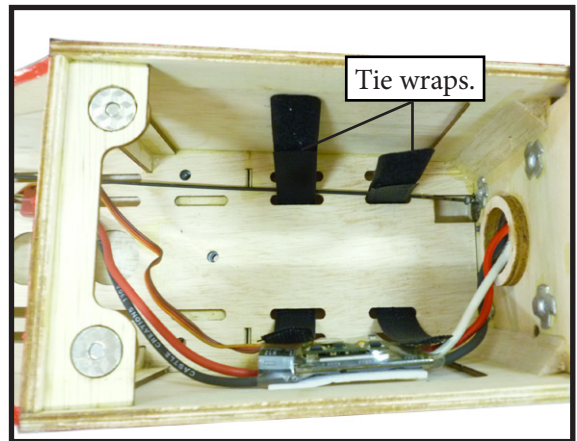
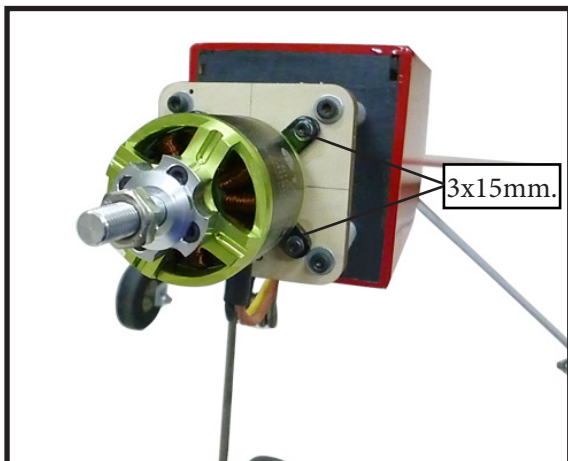
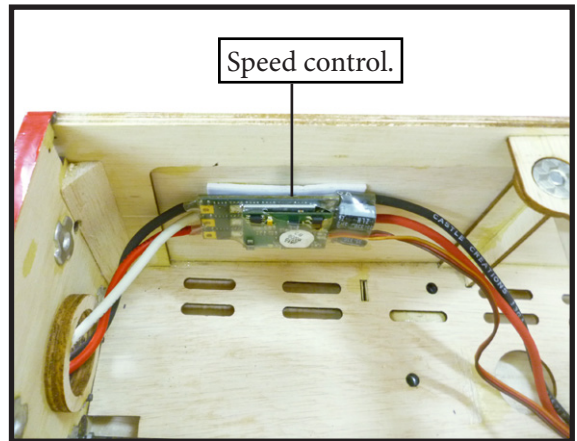
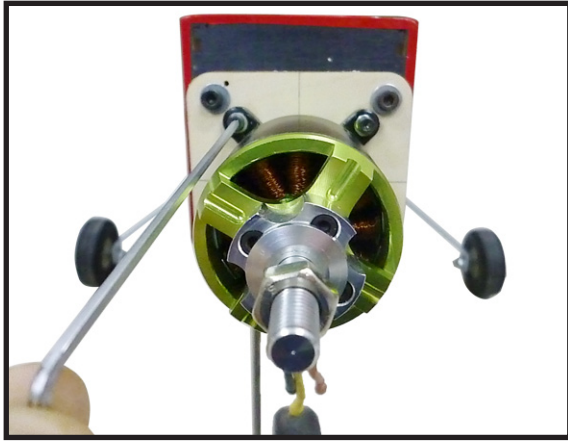

INSTALLING THE SPINNER.

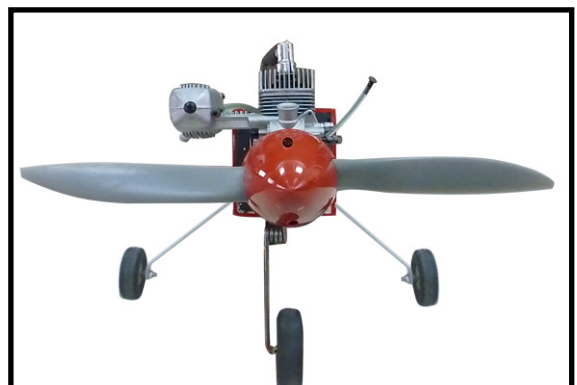
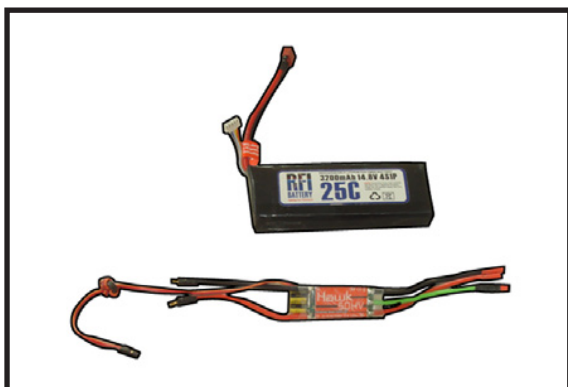

 The propeller should not touch any part of the spinner cone. If it does, use a sharp modeling knife and carefully trim away the spinner cone where the propeller comes in contact with it.



INSTALLING THE MAIN LANDING GEAR.

NOTE : *You must now decide if you will assemble the Classic Ugly Stick with tricycle landing gear or as a tail dragger. If you are assembling as a tail dragger, please skip the nose gear installation steps and mount the main gear to the FORWARD mounting location. If you are assembling using the tricycle landing gear, please skip the tail wheel installation steps, Install the nose gear, and mount the main gear to the REAR mounting location.*

- 1) The blind nuts for securing the landing gear are already mounted inside the fuselage.
- 2) Using the hardware provided, mount the main landing gear to the fuselage.
- 3) Place the fuselage inverted on the work bench in a suitable stand. Set the landing gear in place and use a screwdriver to secure the landing gear to the fuselage using bolts M4x20mm and washers. Make sure to use the threadlock on the bolts so they don't vibrate loose.

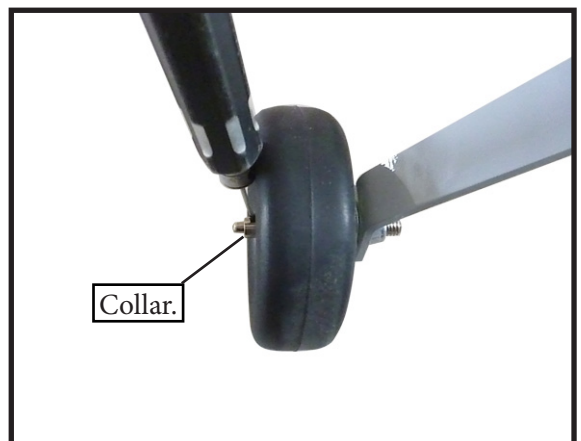
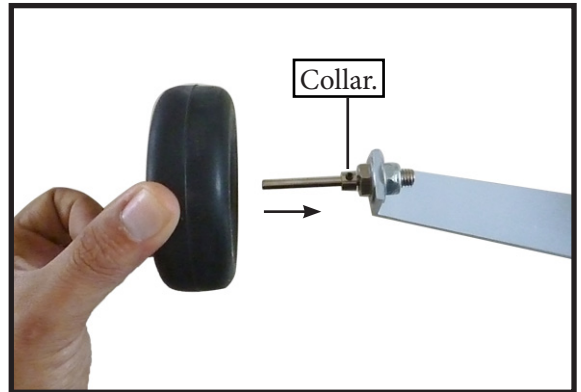
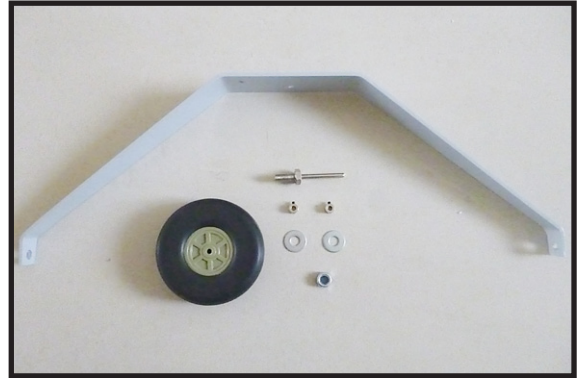

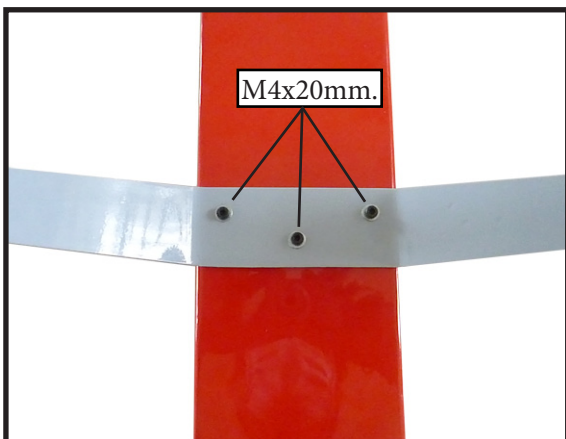
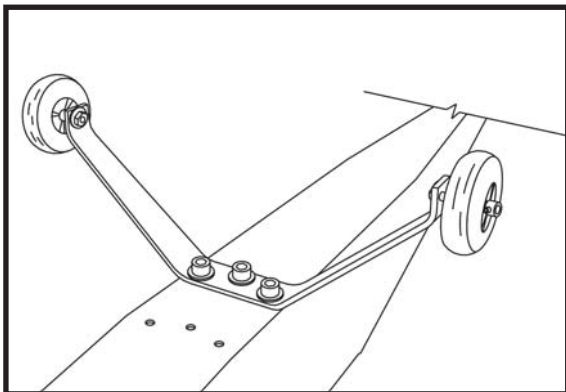
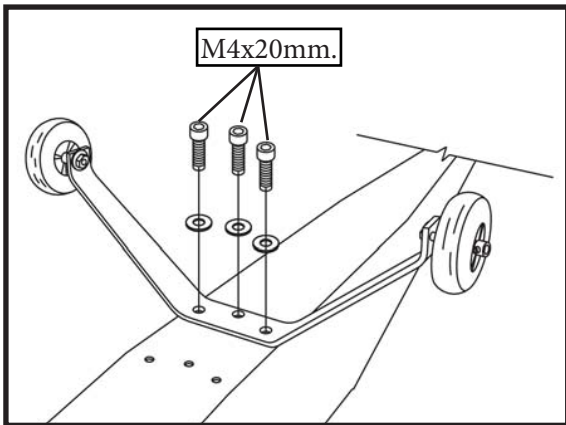
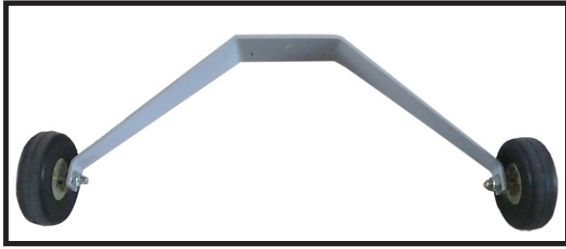

NOSE GEAR INSTALLATION.

Please see below pictures

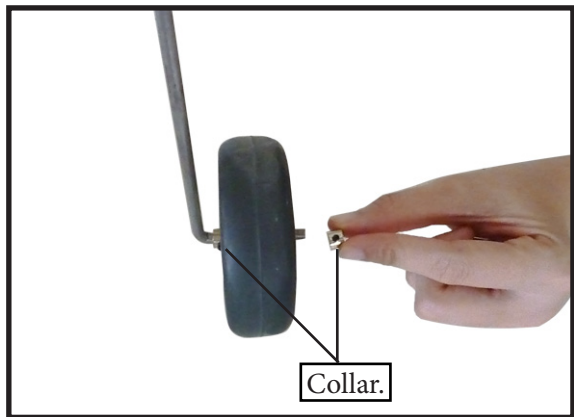
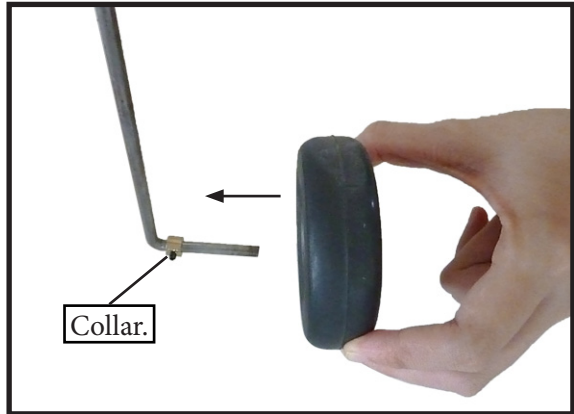

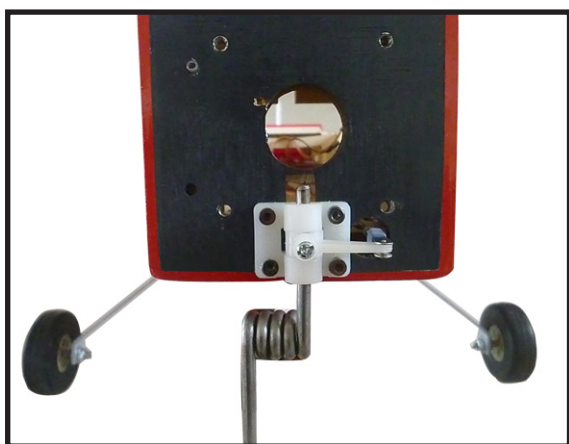
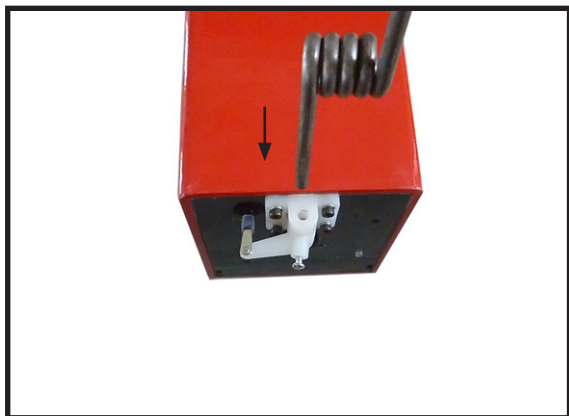
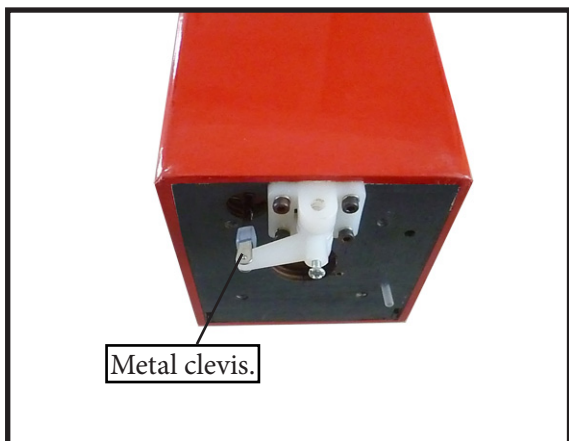
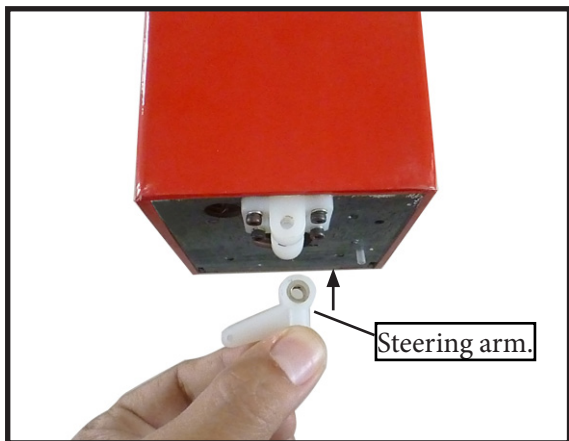

HINGING THE ELEVATORS.

Glue the elevator hinges in place using the same techniques used to hinge the ailerons.

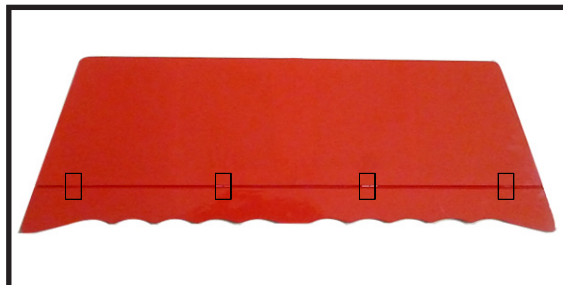

HORIZONTAL STABILIZER.

1) Using a ruler and a pen, locate the center-line of the horizontal stabilizer, at the trailing edge, and place a mark. Use a triangle and extend this mark, from back to front, across the top of the stabilizer. Also extend this mark down the back of the trailing edge of the stabilizer.

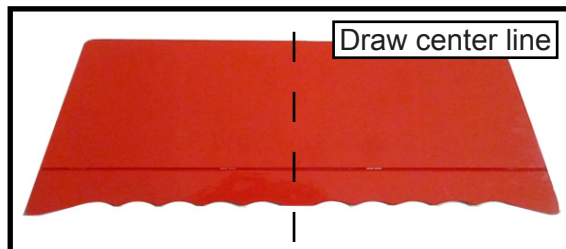

2) Using a modeling knife, carefully remove the covering from over the vertical stabilizer mounting slot in the top of the fuselage.

3) Slide the stabilizer into place in the precut slot in the rear of the fuselage. The stabilizer should be pushed firmly against the front of the slot.

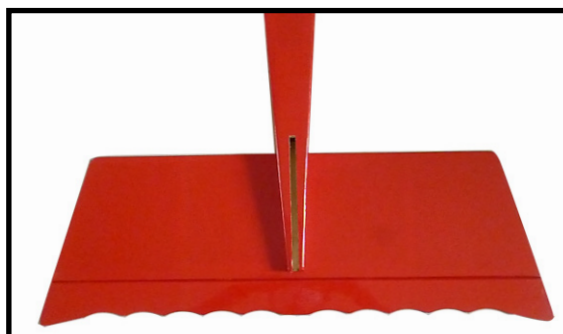

4) With the stabilizer held firmly in place, use a pen and draw lines onto the stabilizer where it and the fuselage sides meet.

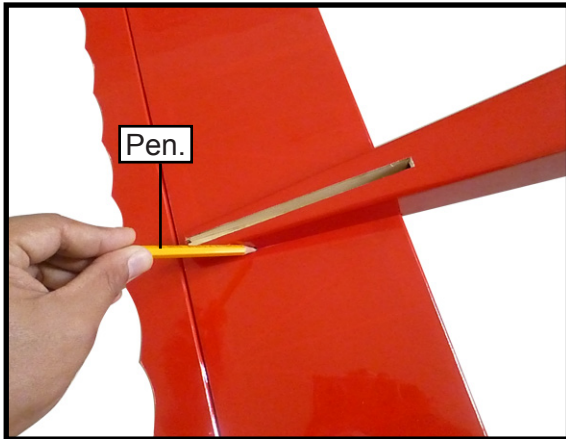

5) Remove the stabilizer. Using the lines you just drew as a guide, carefully remove the covering from between them using a modeling knife.

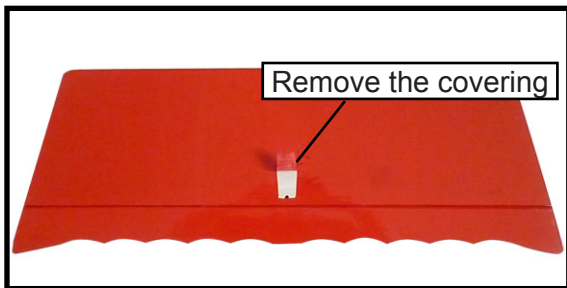

⚠ When cutting through the covering to remove it, cut with only enough pressure to only cut through the covering itself. Cutting into the balsa structure may weaken it.

6) Using a modeling knife, carefully remove the covering that overlaps the stabilizer mounting platform sides in the fuselage.

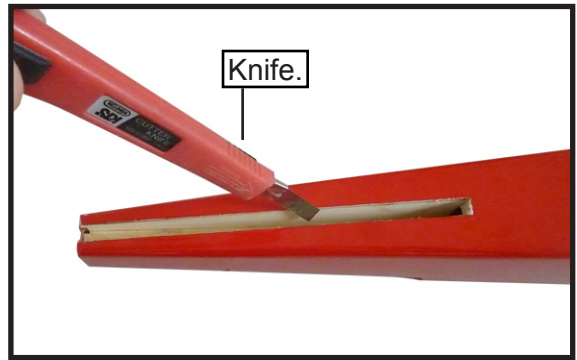
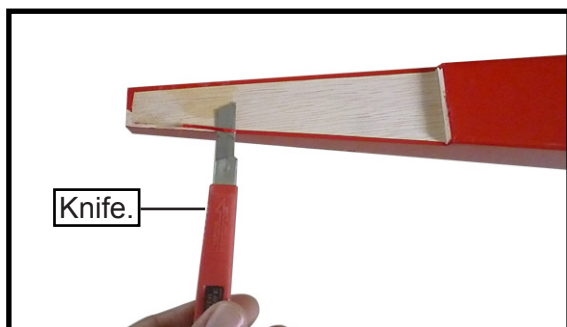

7) When you are sure that everything is aligned correctly, mix up a generous amount of 30 Minute Epoxy. Apply a thin layer to the top of the stabilizer mounting area and to the stabilizer mounting platform on the bottom of the fuselage. Put the stabilizer in place and realign. Double check all of your measurements once more before the epoxy cures. Hold the stabilizer in place with T-pins or masking tape and remove any excess epoxy using a paper towel and rubbing alcohol.

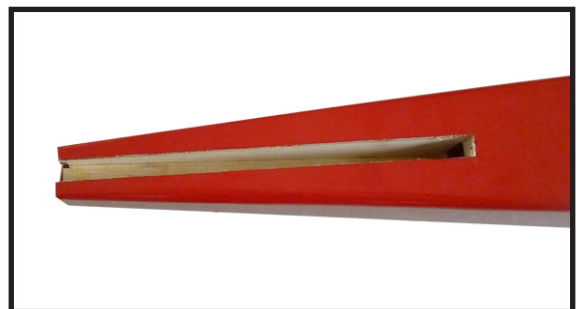
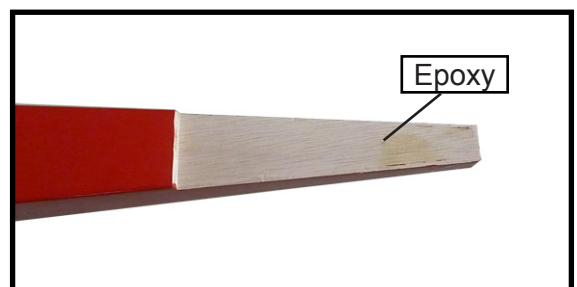
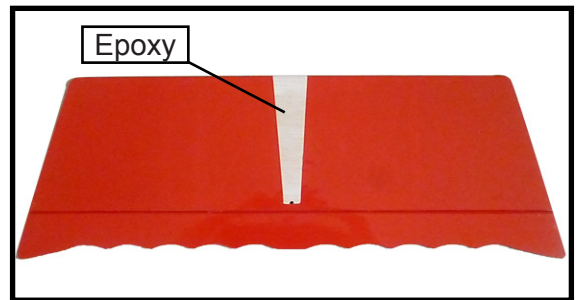

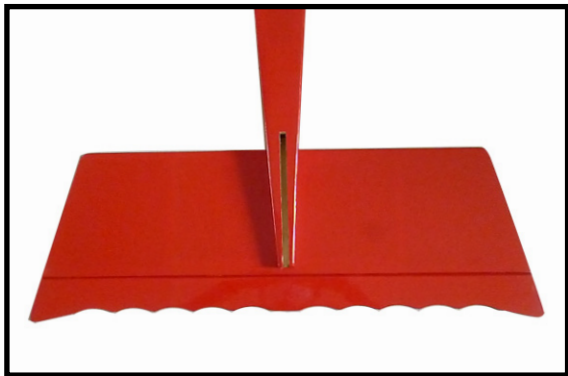

**VERTICAL STABILIZER
INSTALLATION.**

1) Slide the vertical stabilizer into the slot in the top of the fuselage. The rear edge of the stabilizer should be flush with the rear edge of the fuselage and the lower rudder hinge should engage the precut hinge slot in the lower fuselage. The bottom edge of the stabilizer should also be firmly pushed against the top of the horizontal stabilizer.

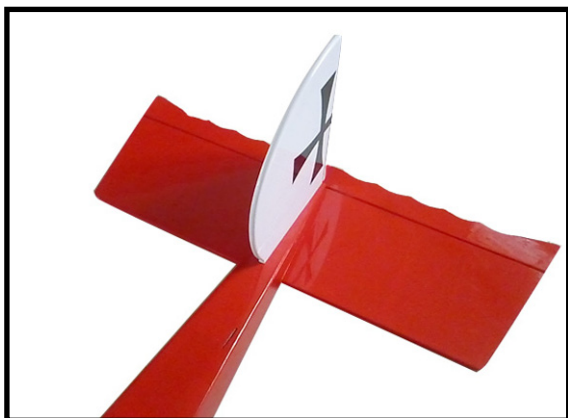

2) While holding the vertical stabilizer firmly in place, use a pen and draw a line on each side of the vertical stabilizer where it meets the top of the fuselage.

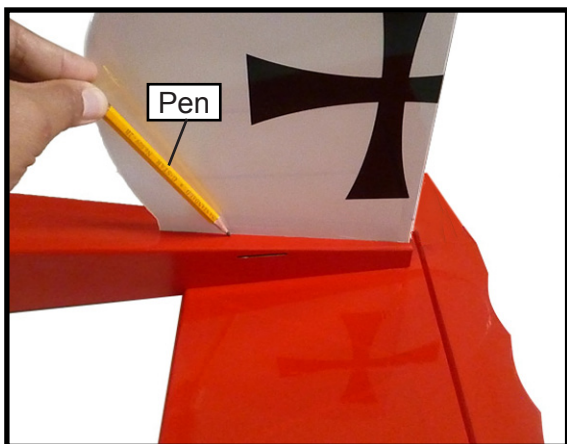

3) Remove the stabilizer. Using a modeling knife, remove the covering from below the lines you drew.

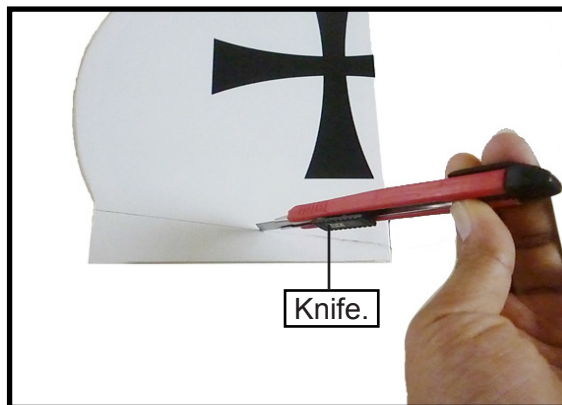

! *When cutting through the covering to remove it, cut with only enough pressure to only cut through the covering itself. Cutting into the balsa structure may weaken it.*

4) Slide the vertical stabilizer back in place. Using a triangle, check to ensure that the vertical stabilizer is aligned 90° to the horizontal stabilizer.

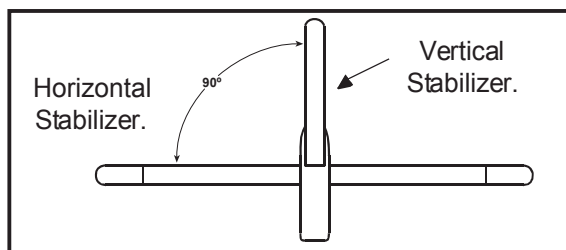

5) When you are sure that everything is aligned correctly, mix up a generous amount of 30 Minute Epoxy. Apply a thin layer to the mounting slot in the top of the fuselage and to the sides and bottom of the vertical stabilizer mounting area. Set the stabilizer in place and realign. Double check alignment once more before the epoxy cures. Hold the stabilizer in place with masking tape and remove any excess epoxy using a paper towel and rubbing alcohol. Allow the epoxy to fully cure before proceeding.

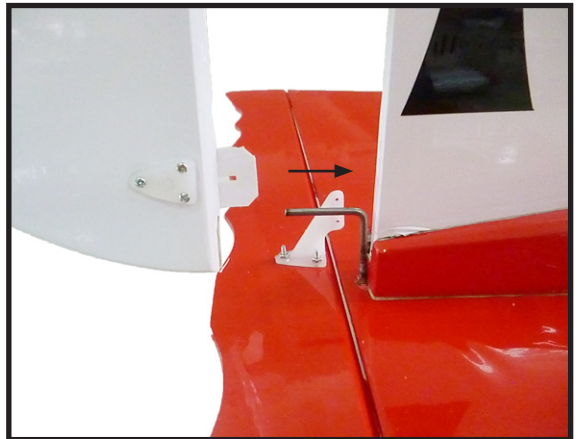
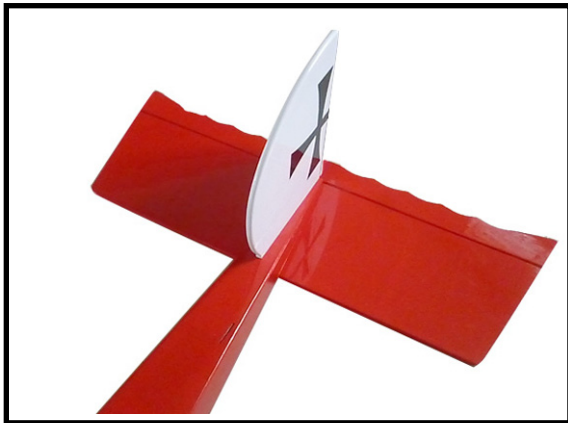
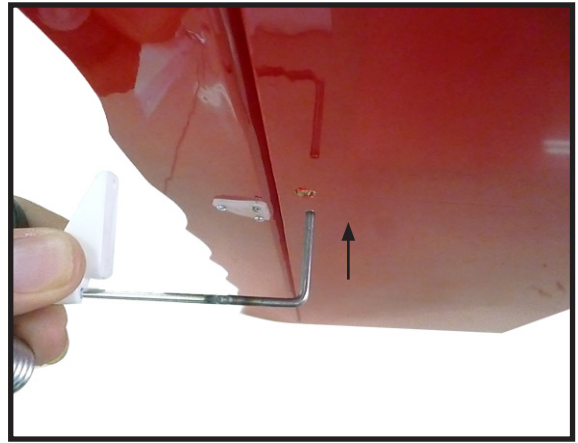

TAIL - DRAGGER CONVERSION.

If you are installing the tail wheel bracket, follow the instructions below. If you have already installed the nose wheel assembly, please skip to hinging the rudder.

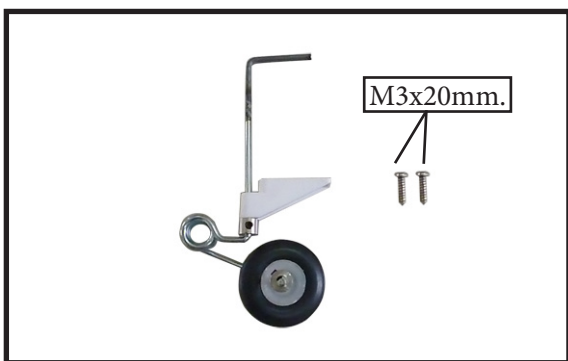

1) Test fit the tail gear to make sure that it fits properly. When you are happy with the fit, attach the tail gear using the two M3x20mm wood screws.



2) See below pictures how to assembly the tail- dragger conversion.

3) Hold the rudder in place and mark it where the music wire will enter. When you are happy with the fit, fill the hole with epoxy and use CA to glue in the rudder hinges.



INSTALL ELEVATOR - RUDDER CONTROL HORN.

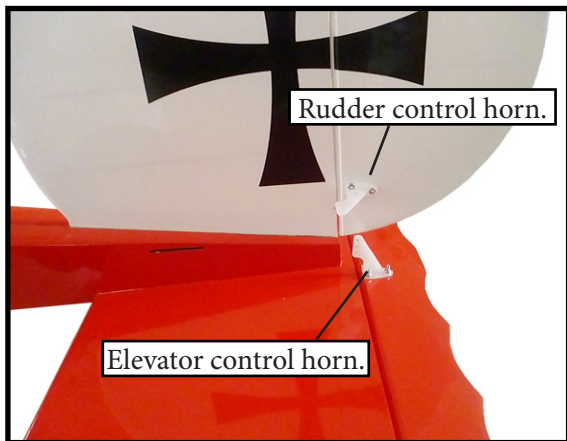
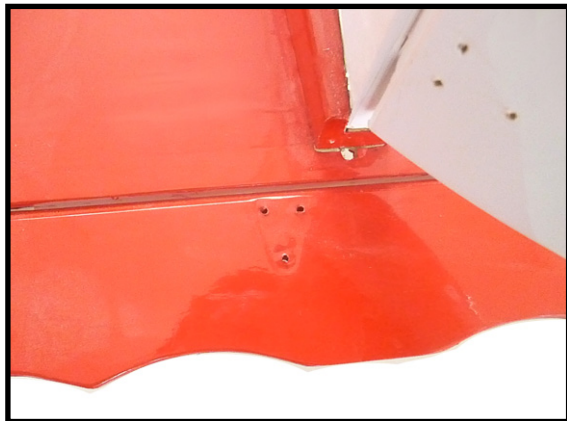

ELEVATOR - RUDDER PUSHROD HORN INSTALLATION.

1) Locate items necessary to install elevator and rudder pushrod.

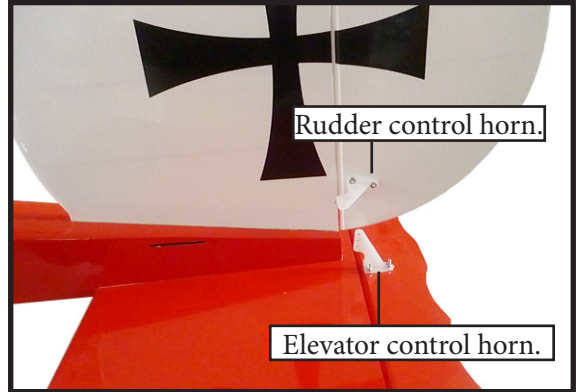

2) Elevator and rudder pushrods assembly as pictures below.

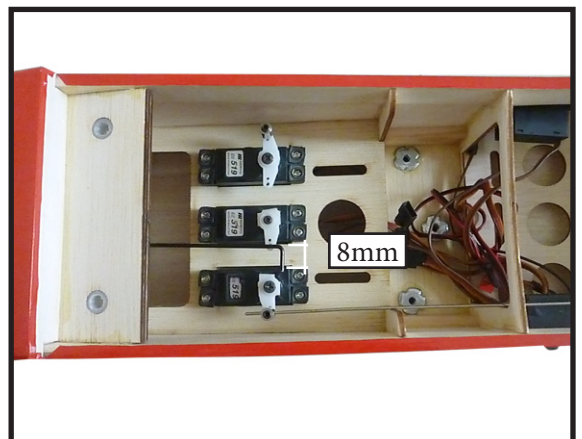
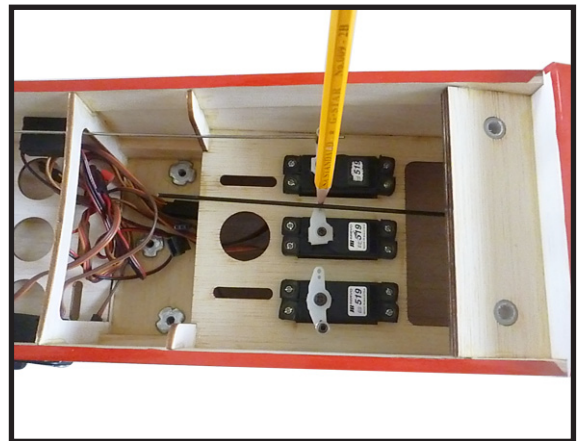
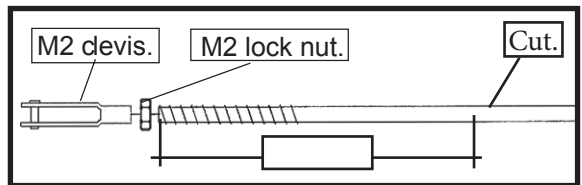

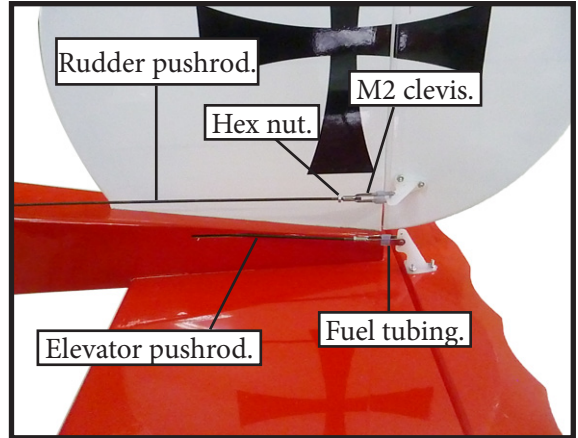
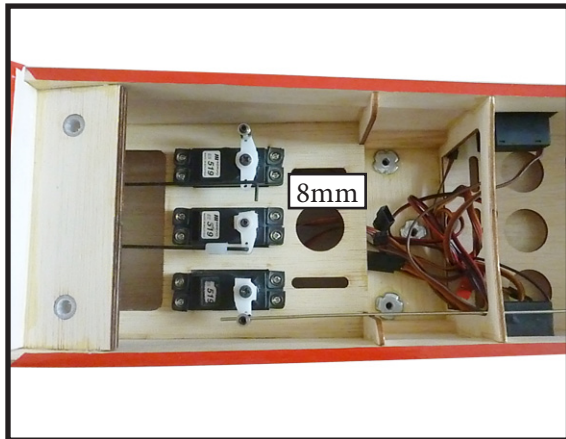
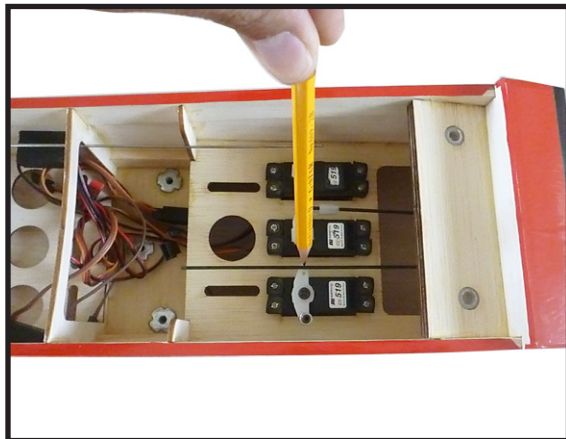
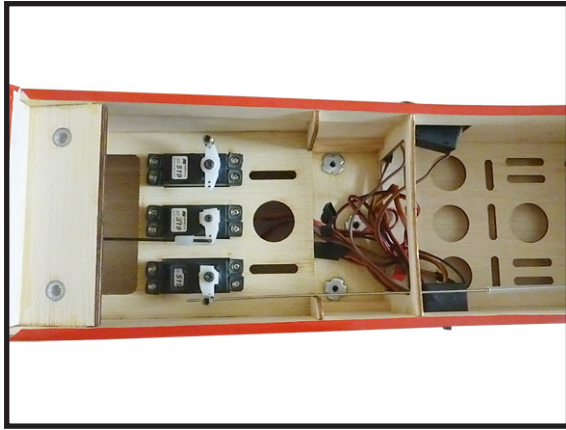

INSTALLING BATTERY - RECEIVER.

- 1) Plug the five servo leads and the switch lead into the receiver. Plug the battery pack lead into the switch also.
- 2) Wrap the receiver and battery pack in the protective foam rubber to protect them from vibration.

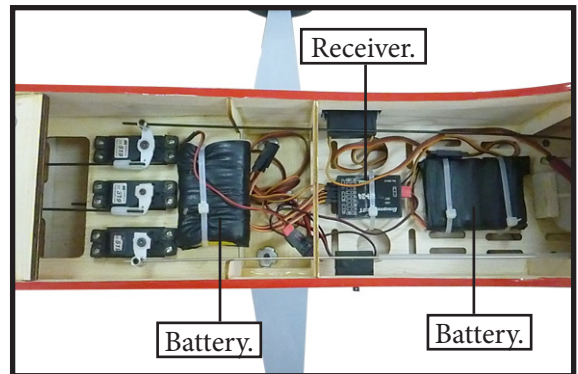

BALANCING.

- 1) It is critical that your airplane be balanced correctly. Improper balance will cause your plane to lose control and crash. **THE CENTER OF GRAVITY IS LOCATED 100 MM BACK FROM THE LEADING EDGE OF THE WING AT THE WING ROOT.**

2) Mount the wing to the fuselage. Using a couple of pieces of masking tape, place them on the bottom of the wing **100mm** back from the leading edge of the wing at the wing root.

3) With the model upright, place your fingers on the masking tape and carefully lift the plane.

The balance point is located 100 mm back from the leading edge of the wing at the wing root. This is the balance point at which your model should balance for your first flights. Later, you may wish to experiment by shifting the balance up to 10mm forward or back to change the flying characteristics. Moving the balance forward may improve the smoothness and arrow- like tracking, but it may then require more speed for take off and make it more difficult to slow down for landing. Moving the balance aft makes the model more agile with a lighter and snappier "feel". In any case, please start at the location we recommend

With the wing attached to the fuselage, all parts of the model installed (ready to fly), and empty fuel tanks, hold the model at the marked balance point with the stabilizer level.

Lift the model. If the tail drops when you lift, the model is "tail heavy" and you must add weight* to the nose. If the nose drops, it is "nose heavy" and you must add weight* to the tail to balance.

*If possible, first attempt to balance the model by changing the position of the receiver battery and receiver. If you are unable to obtain good balance by doing so, then it will be necessary to add weight to the nose or tail to achieve the proper balance point.

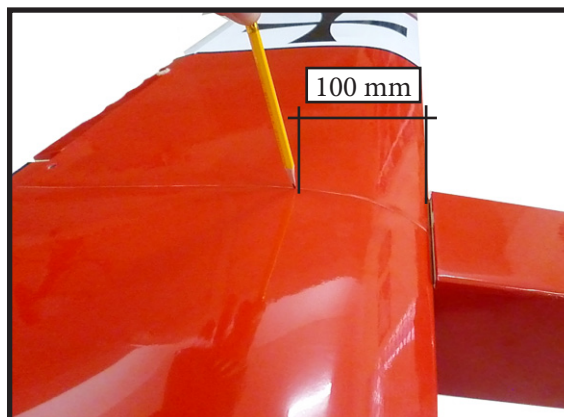

CONTROL THROWS.

Ailerons:

12mm - 15mm up.

12mm - 15mm down.

Elevator:

12mm - 15mm up.

12mm - 15mm down.

Rudder:

20mm - 30mm left.

20mm - 30mm right.

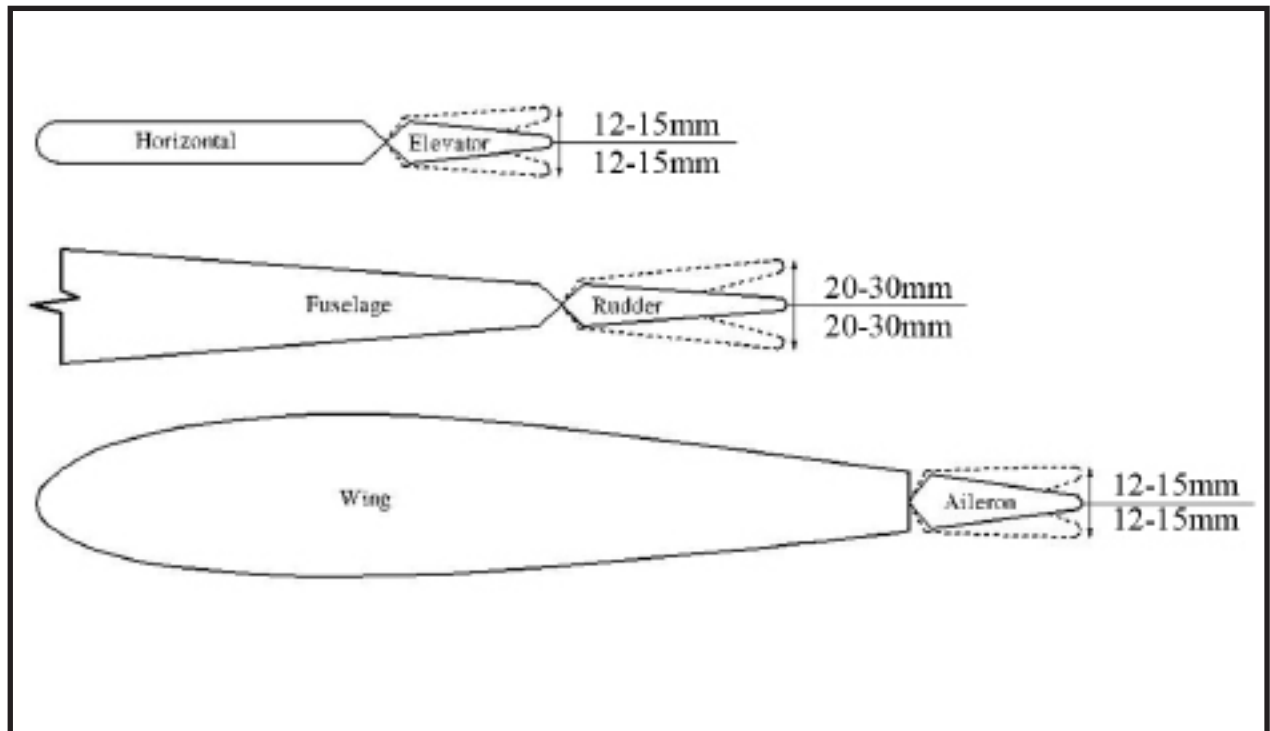

FLIGHT PREPARATION.

Check the operation and direction of the elevator, rudder, ailerons and throttle.

A) Plug in your radio system per the manufacturer's instructions and turn everything on.

B) Check the elevator first. Pull back on the elevator stick. The elevator halves should move up. If it they do not, flip the servo reversing switch on your transmitter to change the direction.

C) Check the rudder. Looking from behind the airplane, move the rudder stick to the right. The rudder should move to the right. If it does not, flip the servo reversing switch on your transmitter to change the direction.

D) Check the throttle. Moving the throttle stick forward should open the carburetor barrel. If it does not, flip the servo reversing switch on your transmitter to change the direction.

E) From behind the airplane, look at the aileron on the right wing half. Move the aileron stick to the right. The right aileron should move up and the other aileron should move down. If it does not, flip the servo reversing switch on your transmitter to change the direction.

PREFLIGHT CHECK.

1) Completely charge your transmitter and receiver batteries before your first day of flying.

2) Check every bolt and every glue joint in the **CLASSIC UGLY STICK** to ensure that everything is tight and well bonded.

3) Double check the balance of the airplane. Do this with the fuel tank empty.

4) Check the control surfaces. All should move in the correct direction and not bind in any way.

5) If your radio transmitter is equipped with dual rate switches double check that they are on the low rate setting for your first few flights.

6) Check to ensure the control surfaces are moving the proper amount for both low and high rate settings.

7) Check the receiver antenna. It should be fully extended and not coiled up inside the fuselage.

8) Properly balance the propeller. An out of balance propeller will cause excessive vibration which could lead to engine and/or airframe failure.

*We wish you many safe and enjoyable flights
with your **CLASSIC UGLY STICK.***